



X SERIES

Product catalogue 2022

Longitudinal seam welding machines

LINEARWELD XP



CONTENT	2
OVERVIEW	4
GENERATION neXt	6
DASHBOARD MONITORING	8
SIMPLE SET UP	10
ADVANCED STORE	12
ADVANCED ADJUSTMENTS	14
REMOTE ACCESS	16
LINEARWELD XP	18
XP - WELDING	20
XP - BENEFITS	22
XP - TECHNICAL SPECIFICATIONS	28
XP - ITEMS	30
NOTES	44

Legal notice

Publisher:

Schnelldorfer Maschinenbau GmbH
 Kappelweg 6
 91625 Schnelldorf
 Germany

Telephone +49 (0) 7950 9889-0
 Fax +49 (0) 7950 9889-29

info@schnelldorfer-maschinenbau.de
 www.schnelldorfer-maschinenbau.de

Name of document:



Product catalogue 2022 - Longitudinal seam welding machine - LINEARWELD XP V1.1 EN

Copyright:

© Schnelldorfer Maschinenbau GmbH
 Passing on and reproduction of this document and the use or disclosure of its contents are prohibited if not explicitly permitted. Any breach or infringement will result in liability for damages. All rights created by patent grant or registration of a utility model or design patent are reserved.

LINEARWELD **XP**



Aerospace- and Bellow industry
Automotive industry
Chimney systems

	00,15 mm - 00,80 mm
	250 mm - 1000 mm
	15 mm - 1050 mm*

LINEARWELD **XD**

LINEARWELD **X**



Aerospace- and Bellow industry
Automotive industry
Tank and Equipment manufacturing
Food technology and kitchen makers
HAVC industry
Vessel construction
Chimney systems

	00,20 mm - 03,00 mm
	200 mm - 1600 mm
	25 mm - 1050 mm*

LINEARWELD **XL** EXTL

LINEARWELD **XL** INEX

Expansionjoint industry
Automotive industry
Tank and Equipment manufacturing
Food technology
HAVC Industry
Construction of machines and housings
Vessel construction
Ducts

	00,50 mm - 15,00 mm
	600 mm - 4100 mm
	80 mm - 1100 mm*

LINEARWELD **XLS** EXTL

LINEARWELD **XLS** INEX

Expansionjoint industry
Tank and Equipment manufacturing
Food technology
HAVC Industry
Construction of machines and housings
Vessel construction
Ducts

	00,50 mm - 15,00 mm
	1600 mm - 4100 mm
	145 mm - 5190 mm

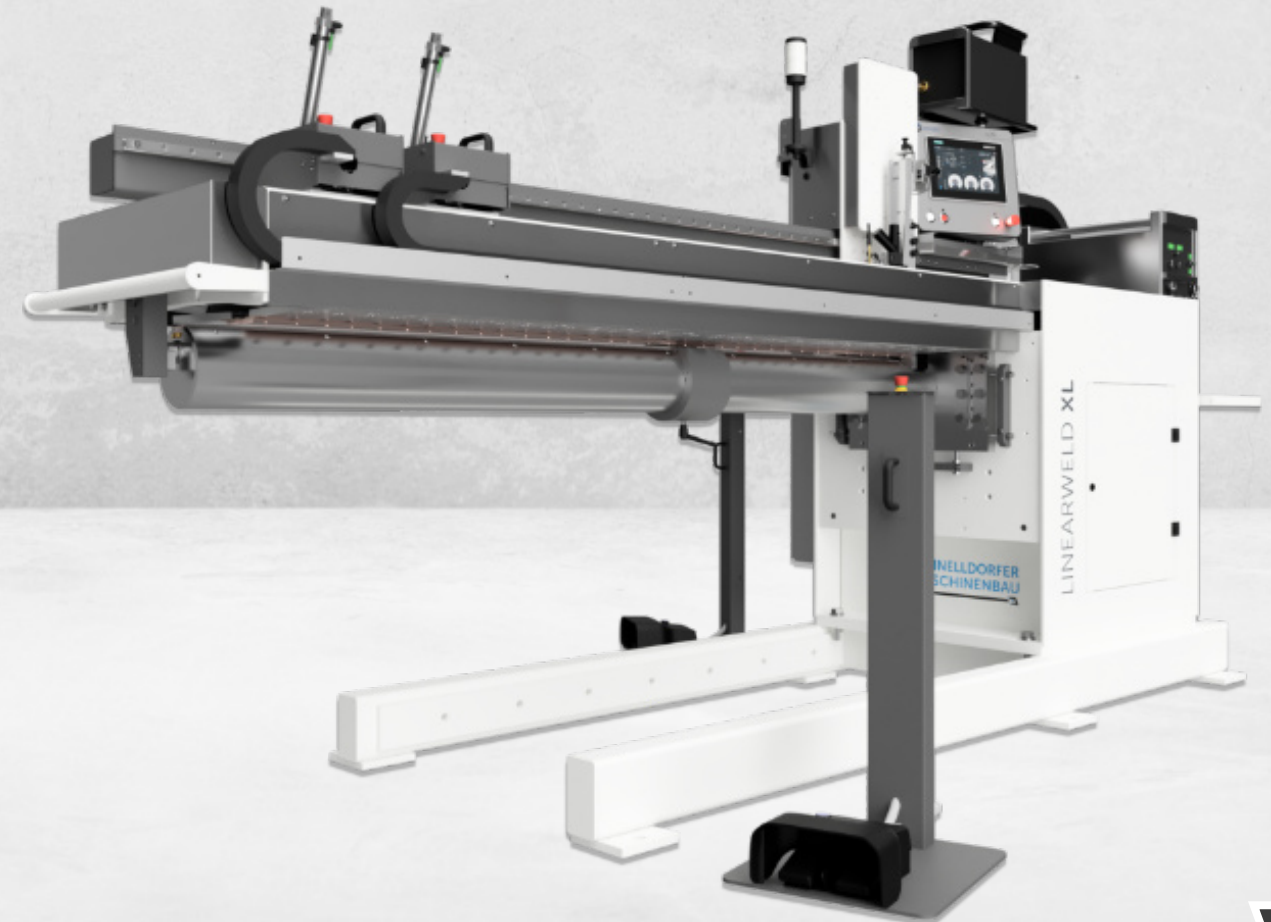





* With standard machine body, bigger diameters possible with hightening elements (option)

Revolutionizes welding automation

Now, there is a brand new machine control which offers you all possibilities of the 21th century and makes you ready for **industry 4.0**.

The **neXt** machine control is part of our seam welding machines made in Germany. Intelligent I/O sensor technology, state of the art machine plc control, smart and intuitive Human Machine Interface and full IOT connectivity takes your production to the neXt level!

 <p>INDUSTRY 4.0</p> <ul style="list-style-type: none"> • Industry 4.0 ready • OPC UA connection • OEE Monitoring • Remote Access 	 <p>EFFICIENCY</p> <ul style="list-style-type: none"> • High reduction of intermediate times • AI assistance systems for faster start up • Operator guidance for more efficiency 	 <p>TPM</p> <ul style="list-style-type: none"> • Constantly actuators check up • Downtime warnings • Reminder message connected via OPC UA 	 <p>TRAINING</p> <ul style="list-style-type: none"> • Intuitive HMI user guide • All functions and buttons visualized with icons • Assistance button on each side 	 <p>PRODUCTION</p> <ul style="list-style-type: none"> • Quality improvement through self-examination • Set Up assistance with show it videos
---	---	---	--	--



OPC UA

IO-Link

WiFi

USB



INDUSTRY 4.0



- Video guided machine control
- Intelligent setting control
- Parameter assistant
- Set Up slide shows
- Visualized error message
- Dashboard selection
- App gallery
- Ready for industry 4.0

Program faster and reduce non-productive times!

Simplify complex processes and make them intuitive to use, this is a challenge that we are always happy to face!

We are sure that this new control concept will exceed all expectations and lift the operator experience into completely new spheres.



VISUALIZATION

100 %

- Intuitiv haptics with full visualized process guidance
- Super high quality look & feel



OEE Monitoring App realtime calculation,

Function Bar

Permanent Bar

Motion Board

Dash Board

Menu Bar

Status Board

Status bar

2/14/2020, 1:13:09 AM Production Name: soft1

Actors: [Icons]
 Position: 476.25 mm 0.00 mm/s
 Options: [Icons]
 Pressure: Front 0.000 bar Rear 0.000 bar
 State: [Icons]
 Quality: 17.442 s

Current [A] 127.9
 X-Axis [mm...sec] 126.7
 X-Axis [mm...sec] 47.3
 Coldwire [cm...min] 127.9
 Coldwire [cm...min] 72.7
 Pulse [Hz] 127.9

Produce more efficiently!

With the software bundel - Simple Set Up - you can increase the efficiency of your production enormously.

Developed for a "one piece flow" production and the requirements of "Total Productive Maintenance", the machine supports the operator as well as the planning.



PERFORMANCE

290 %

- More PLC Control performance
- I/O Link - intelligent sensorics
- ProfiNET

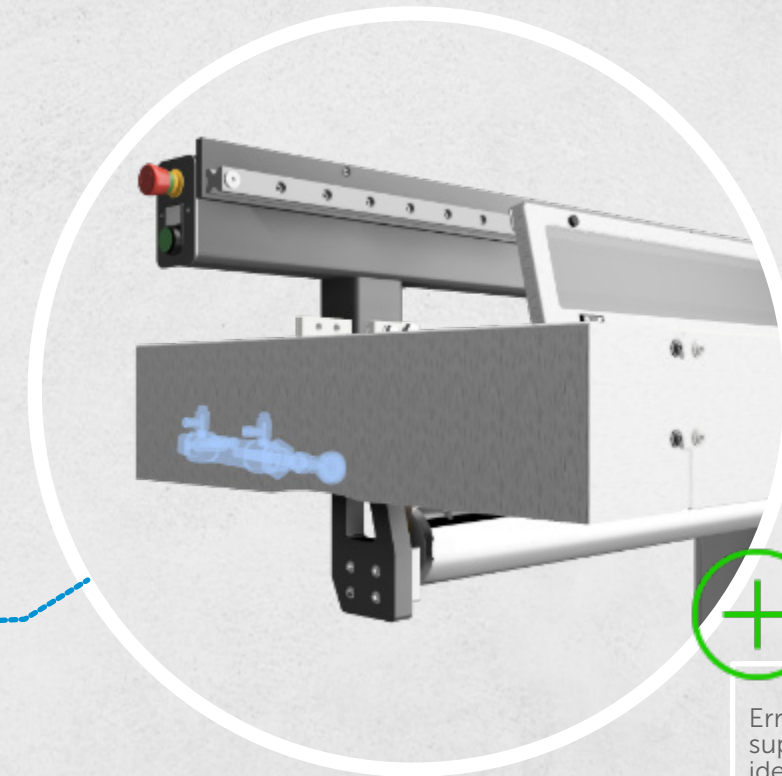

Error and warning messages, visually supported for quick and clear identification

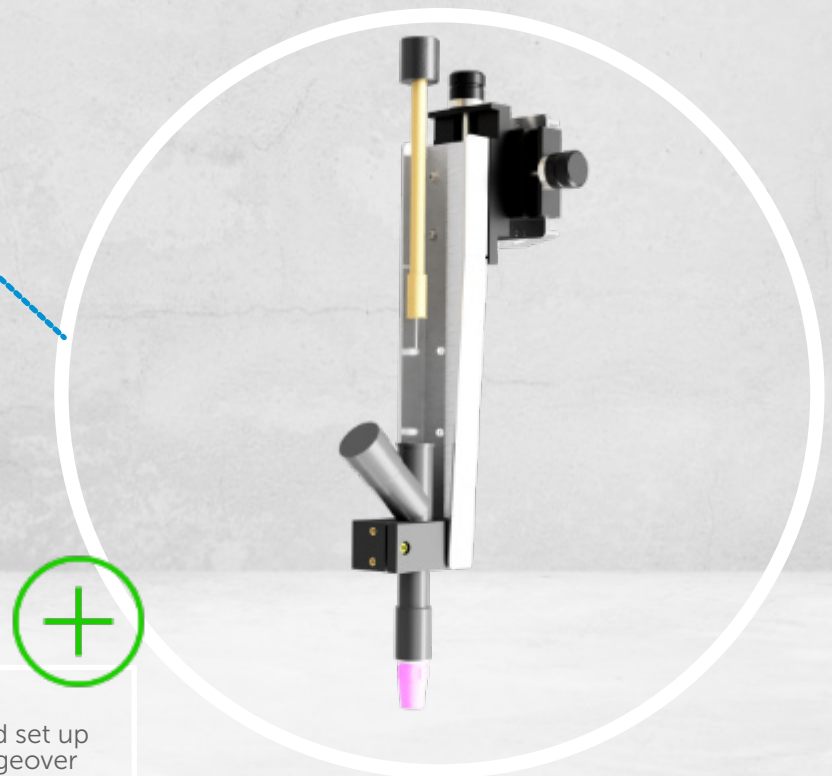

Slide show video supported set up for a fast and reliable changeover

Stay in the loop!

The challenge of producing ever-smaller series with utmost flexibility can often result in a hectic working space and time pressure. This also increases the risk of errors. Using the software bundle - ADVANCED STORE, you can take steps to address this by making your order management transparent. This option enables you to control your production and manage all production orders. As a result, you avoid errors and delays while staying in the loop at all times.



DATA STORE

400 %

- More storage space and performance
- Brand new product-catalogue function
- Online / offline compare function



Pre installed Parameter Database, for a wide range of different materials and thicknesses



Parameter upload by Data code reader

Improve your quality!

Automatic welding is high-tech teamwork of various system components. Only when they work together perfectly, there are outstanding welding results of high economic efficiency guaranteed. It always comes on the detail - from the transport of the components to the ignition of the arc.

The intelligent and precise interaction of all modules involved in the welding process guarantees the constant and always reproducible quality of the weld seams.



Plausibility control function helps you to set up the machine always right



Direct access for main setting in the dashboard function



FUNCTIONS

33 %

- More Adjustment possibilities and parameters available
- Plausibility control function
- Simulation mode

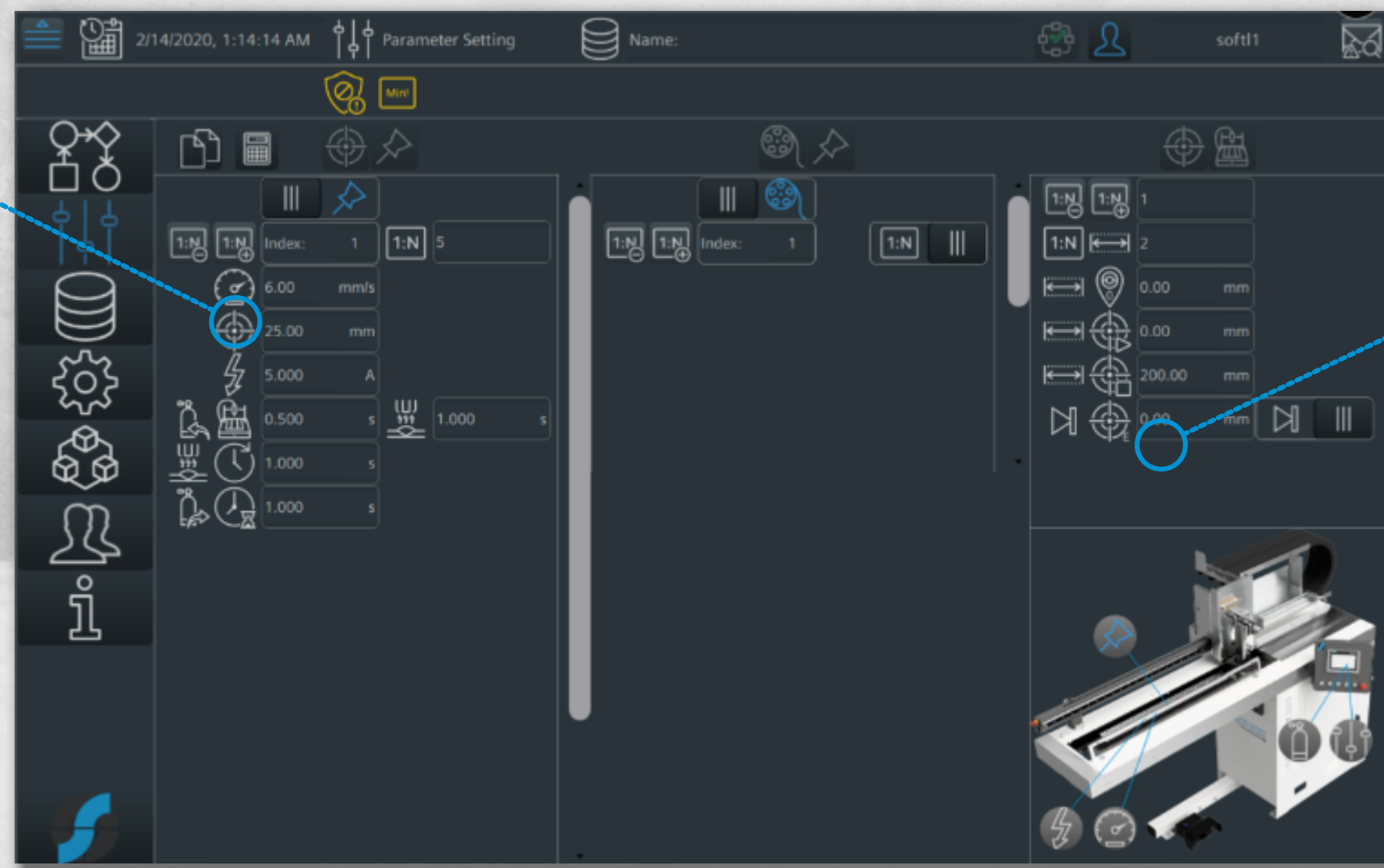

Always keep an eye on the production processes. At any time. From everywhere.

With the software bundle - Remote Access, you have full connectivity, monitoring and analysis. In this way you avoid machine and production downtimes and create maximum transparency



INDUSTRY 4.0

100 %

- Ready for industry 4.0
- OPC UA Server & Client mode
- AI (artificial intelligence) Parameter controle



Mirrored HMI screen on mobile devices and on web based platform

 Smart Server

OPC UA connection and Sm@rt server function



All Sensor- and production data's shared in real time





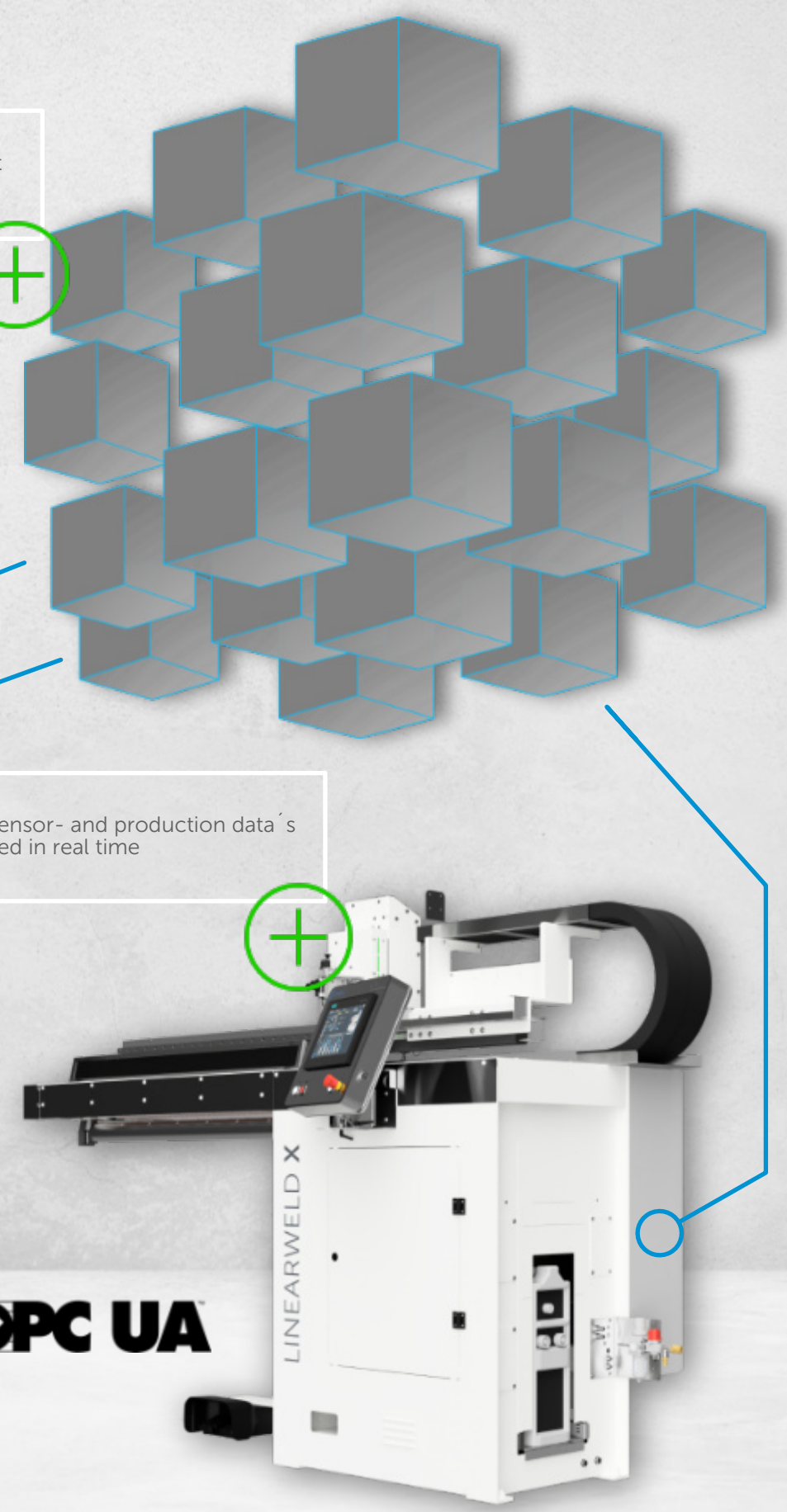

Xtra in Precision

High quality and productive longitudinal seam welding requires the use of **advanced and superior technologies**. This enables us to protect and expand our market position.

Our LINEARWELD XP-Series longitudinal seam welding machines offer unsurpassed technology for **welding metallic longitudinal seams**.

The **XP** series stands for **maximum precision** with the **smallest pipe diameters**. With its unique machine technology, the LINEARWELD XP offers **unrivaled productivity**.

The LINEARWELD machine type is characterized by the **best quality, simple operation and high speeds**.

Available in various welding lengths from 250 mm to 1000 mm, the highly modular system with many equipment variants enables quick adaptation to **your individual needs**.



00,15 mm - 00,80 mm



250 mm - 1000 mm



15 mm - 1050 mm*



Stainless Steel | Mild Steel | Carbon Steel | Galvanized Steel | Aluminium | Titanium | Copper



+ HIGHEST PRECISION FOR PERFECT WELDING

- Ergonomic design
- Weld seams with no discolouration
- Welding without deformation of the workpiece
- High reproducibility
- Precise torch motion
- Highest quality welding results
- Quick-change system for the backing track
- Intuitive user interface with clear program management
- High-grade components

* With standard machine body, bigger diameters possible with hightening elements (option)

Perfect welds from the first part

This helps improving the quality of your products as well, particularly if you are interested in a professional design.
The increased quality level of your products strengthens your image, justifies higher prices and thus improves your chances on the market



Thin metal compensator below
T: 0,2 mm
SOFT PLASMA



Stainless Steel pipe
T: 0,3 mm
TIG

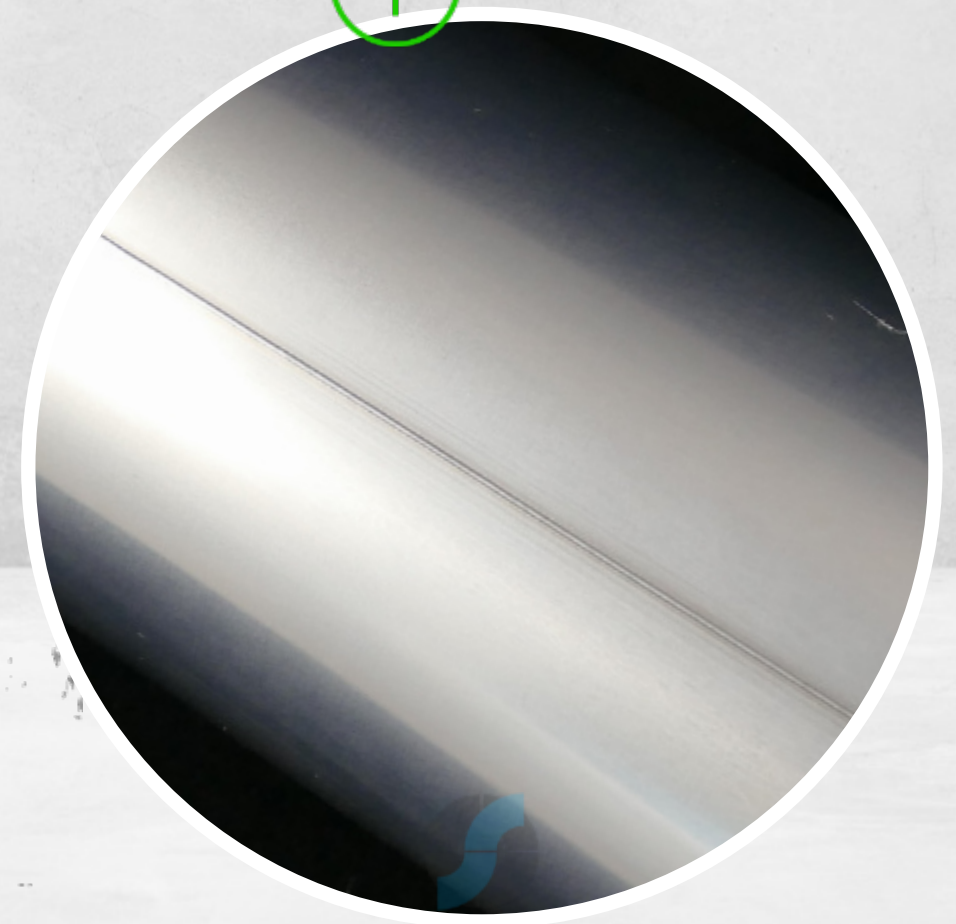
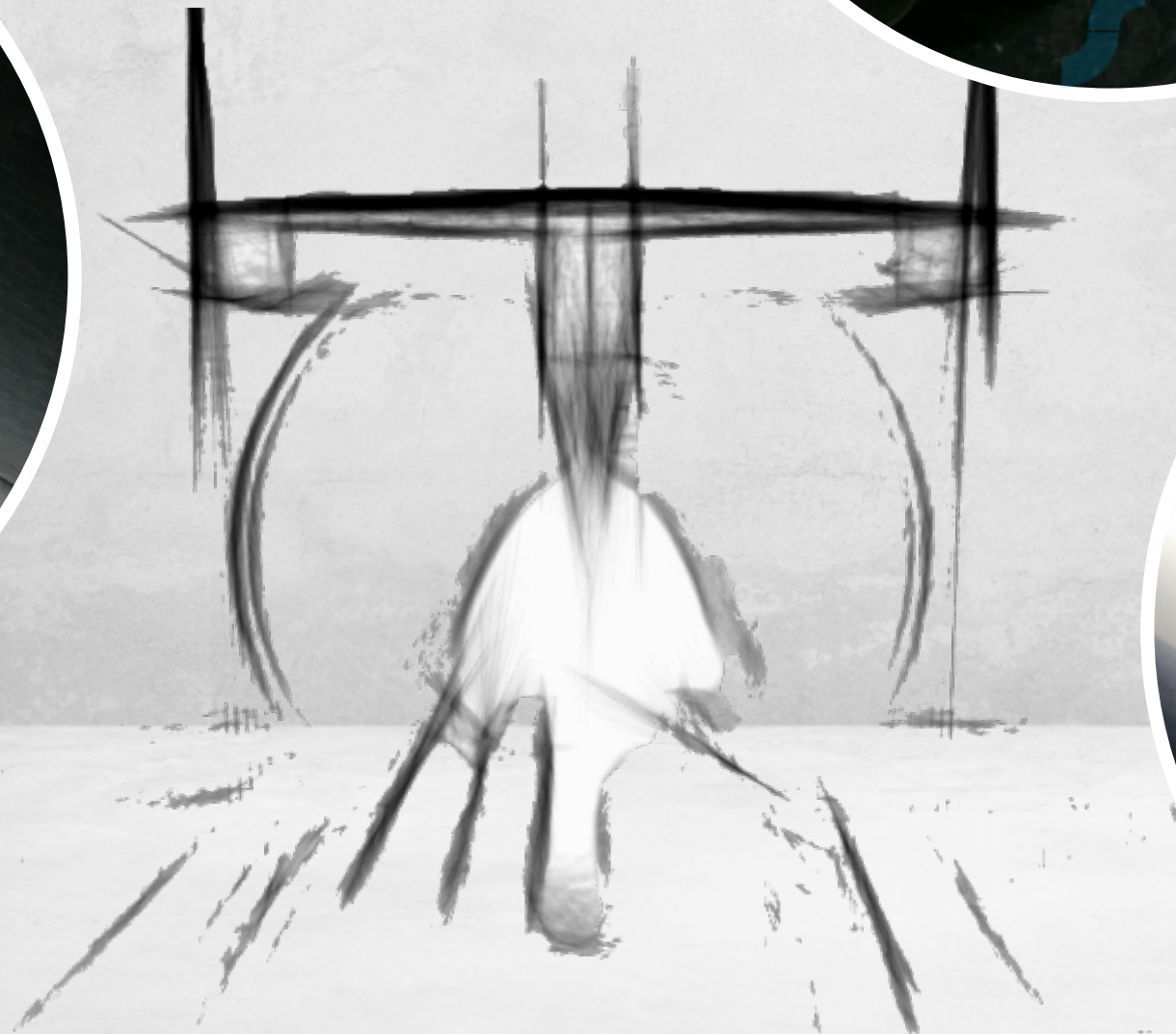

Inconel tube
T: 0,15 mm
TIG



Ready to weld!



Minimal distortion of welded parts



Utilisation of all common welding processes



Wide range of control options



Easy to use



Increased welding speed



Reducing of overall cycle time

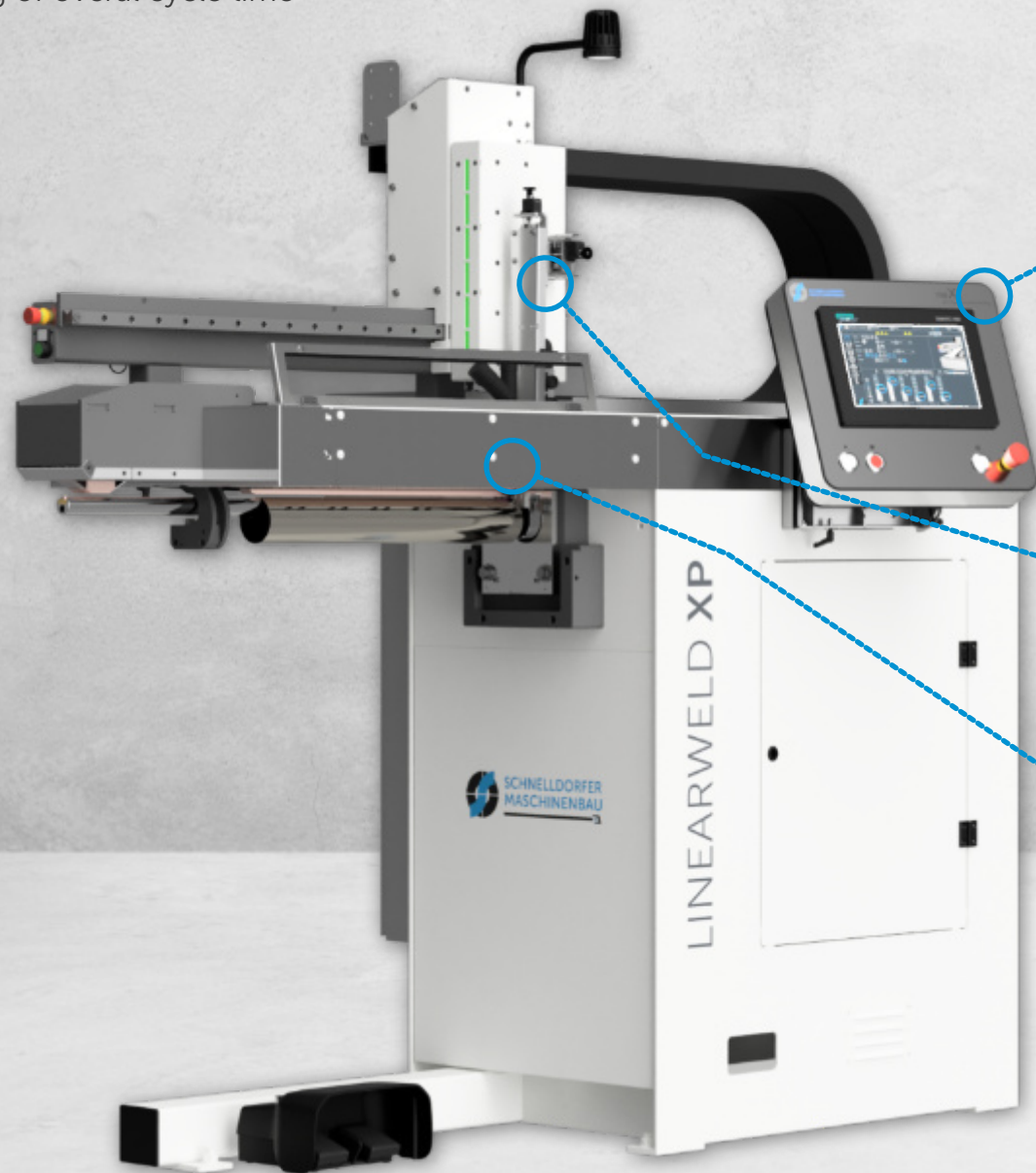

SIEMENS UNIFIED HMI
Equipped with the best welding automation software on the market



Torch support with counter in combination with Touch & Signal software function makes tungsten setting 100% reliable and easy

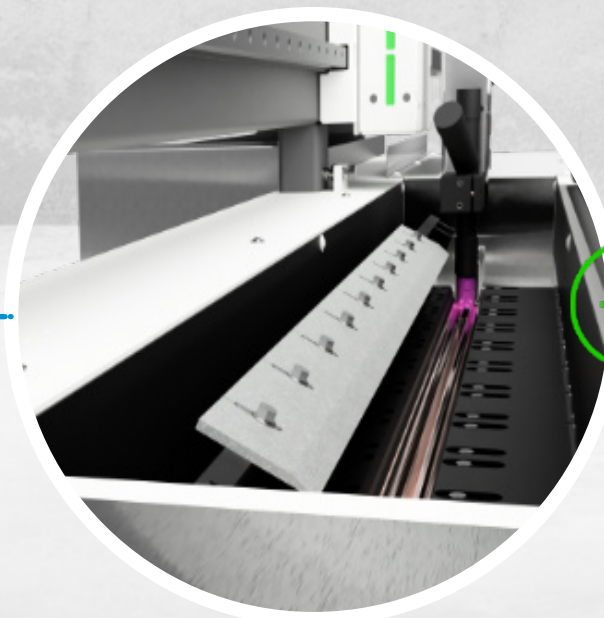
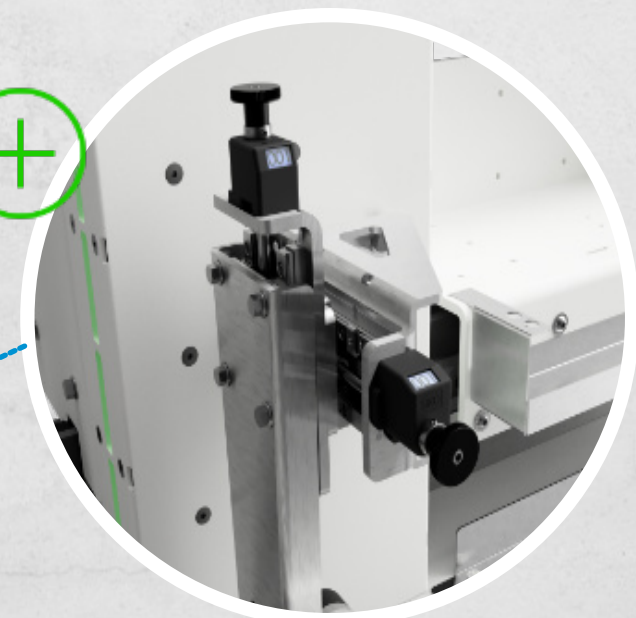

High precision center stop and pre clamp function, for the fastest and most comfortable insertion of the parts

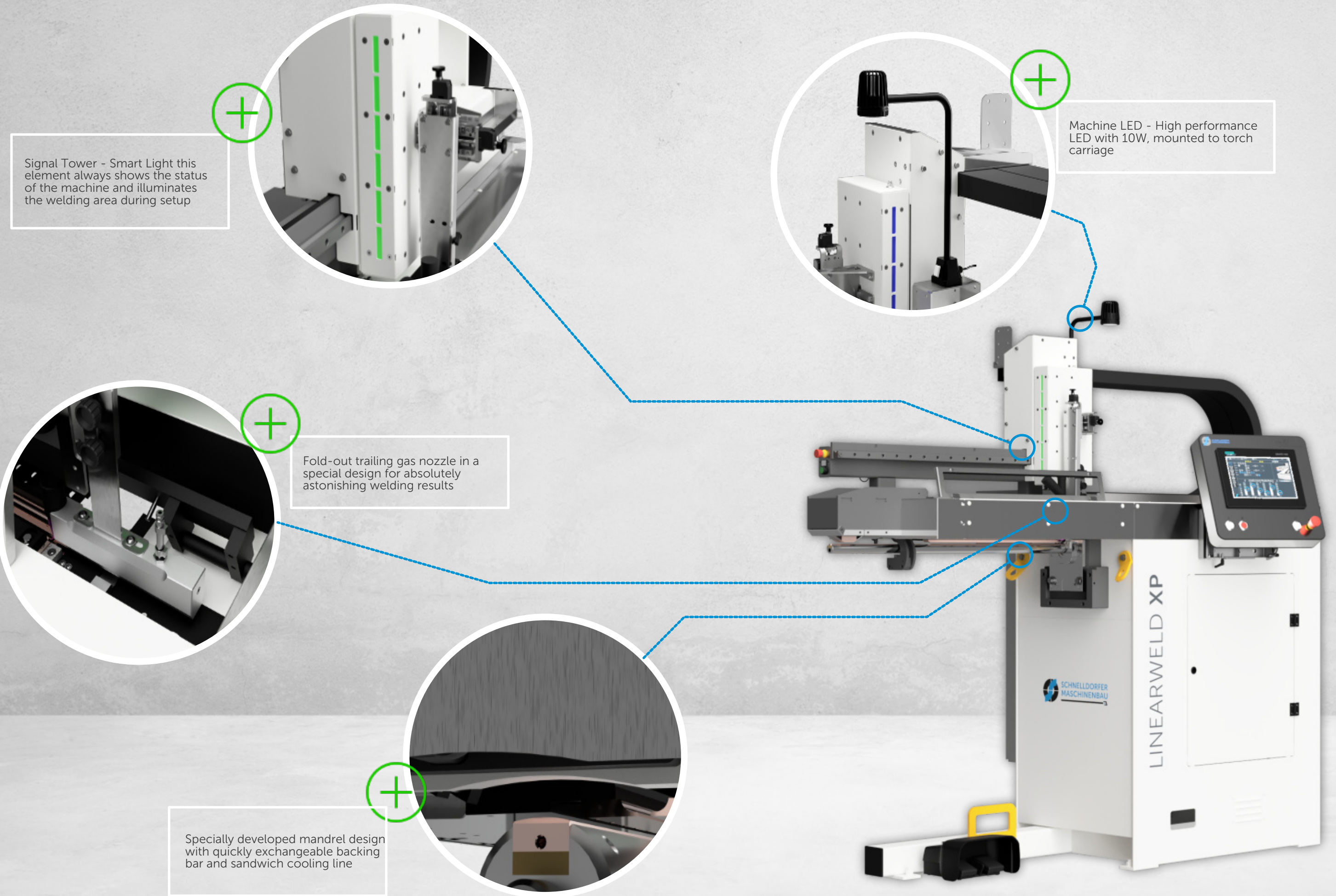

Signal Tower - Smart Light this element always shows the status of the machine and illuminates the welding area during setup

Machine LED - High performance LED with 10W, mounted to torch carriage

Fold-out trailing gas nozzle in a special design for absolutely astonishing welding results

Specially developed mandrel design with quickly exchangeable backing bar and sandwich cooling line

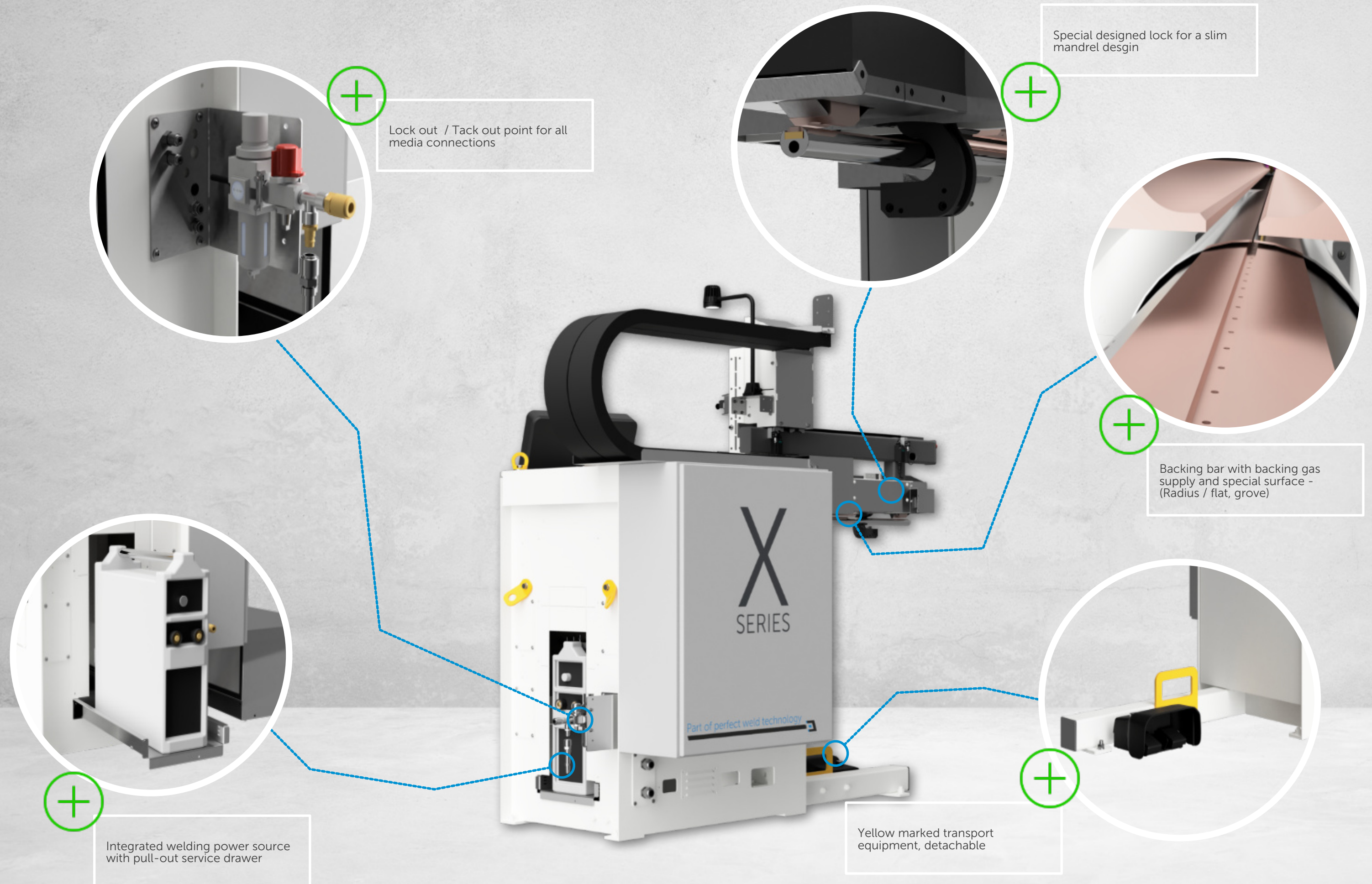

+ Lock out / Tack out point for all media connections

+ Special designed lock for a slim mandrel design

+ Backing bar with backing gas supply and special surface - (Radius / flat, groove)

+ Yellow marked transport equipment, detachable

+ Integrated welding power source with pull-out service drawer

LINEARWELD XP	250	350	450	600	800	1000
Max. welding length [mm]	252	352	452	602	802	1002
Min. Diameter (inside) [mm]	15	21	27	32	40	50
Max Diameter (outside) [mm]	1050 mm (optional hightening elements . +250 / +500 / +750 / +1000)					
Material type	Stainless Steel, Mild Steel, Carbon Steel, Galvanized Steel, Aluminium, Titanium,					
Material thickness [mm]	00,15 mm - 00,80 mm					
Backing bar	Sandwich technology, changable without any media connection, fast exchange fixure					
Clamping system	Pneumatic, Pre-clamp feature					
Arc Length	Constant , over whole welding length (tolerances of 0,05 mm)					
Mandrel lock	Pneumatic, position controlled					
Welding process	TIG, High performance TIG, Micro & Softplasma					
Welding direction	free selectable					
Gas	Torch Gas, Backing Gas, Trailing Gas, Clamping finger gas (option)					
Cooling Circuit	Mandrel / Backing bar, Torch					
Colour	Traffic White - RAL 9016 (powder coated, matt, structure) & Slate Grey - RAL 7015					
Control	Siemens S7-1515					
Operator Panel	SIEMENS SINAMIC - Unified Comfort Panel					
Motor	SIEMENS SINAMIC - S210 Servo motor					
Welding Interface	ProfiBus / ProfiNet					
Standard	CE-Mark / UL-prepared					
Electric Supply	400/230 Volt / 3 / N / PE; 50/60 Hz; TN-grid					
Air Supply	6 bar, dry, filtered					
Ambient Temperature	+ 10°C to + 35°C					

MACHINES



LINEARWELD X

Item No.	Item	Info
11.0250.0000	LINEARWELD XP 250	250 mm welding length
11.0350.0000	LINEARWELD XP 350	350 mm welding length
11.0450.0000	LINEARWELD XP 450	450 mm welding length
11.0600.0000	LINEARWELD XP 600	600 mm welding length
11.0800.0000	LINEARWELD XP 800	800 mm welding length
11.1000.0000	LINEARWELD XP 1000	1000 mm welding length

FUNCTION ITEMS



MANDREL

Item No.	Item	Info
11.length.0001	Mild Steel	
11.length.0002	Stainless Steel	
11.length.0003	Vanadis 30	



HMI DISPLAY

Item No.	Item	Info
10.0010.0002	Control Panel, HMI - Touch Screen 12"	Touch



CLAMPING FINGERS

Item No.	Item	Info
10.0011.0001	50 mm UNI	CU
10.0011.0002	50 mm THIN	CU
10.0011.0003	50 mm GAS	CU
10.0011.0004	50 mm SOFT	Stainless Steel
10.0011.0011	100 mm UNI	CU
10.0011.0012	100 mm THIN	CU
10.0011.0013	100 mm GAS	CU
10.0011.0014	100 mm SOFT	Stainless Steel



BACKING BAR

Item No.	Item	Info
11.length.0011	UNI - Radius	CU (t= 0,4 mm - 2,5 mm)
11.length.0012	UNI - Flat	CU (t= 0,4 mm - 2,5 mm)
11.length.0013	THIN - Radius	CU (t= 0,2 mm - 0,5 mm)
11.length.0014	THIN - Flat	CU (t= 0,2 mm - 0,5 mm)
11.length.0015	SOFT - Radius	SS (t= 0,7 mm - 3,0 mm)
11.length.0016	SOFT - Flat	SS (t= 0,7 mm - 3,0 mm)

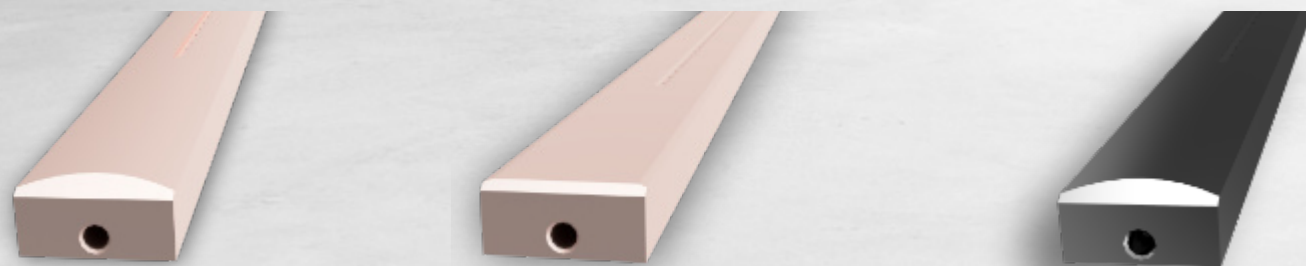

TORCH LIFT

Item No.	Item	Info
10.0012.0001	Standard	Pneumatic
10.0012.0002	Motor	Electric
10.0012.0003	AVC (Arc Voltage Control)	Sensoric

STANDARD

Item No.	Item	Info
10.0013.0001	CE - Conformity (Labeled)	X-Series
10.0013.0002	UL - Conform (unlabeled)	X-Series

COLOR

Item No.	Item	Info
10.0015.0001	Standard	Traffic White & Slate Grey
10.0015.0002	Body customized	Additional - Slate Grey
10.0015.0003	Complete customizedd	RAL

HARDWARE OPTIONS



CENTER STOP

Item No.	Item	Info
11.length.0301	Standard, swivling	X-Series

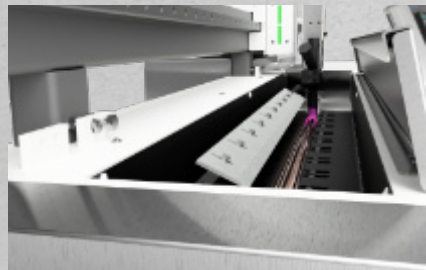

HIGHTENING ELEMENT

Item No.	Item	Info
10.0014.0250	250 mm	XP, XD, X
10.0014.0500	500 mm	XP, XD, X
10.0014.0750	750 mm	XP, XD, X
10.0014.1000	1000 mm	XP, XD, X
10.0014.1500	1500 mm	XP, XD, X

LASERPOINTER

Item No.	Item	Info
11.length.0310	Laserpointer	Front 6 back

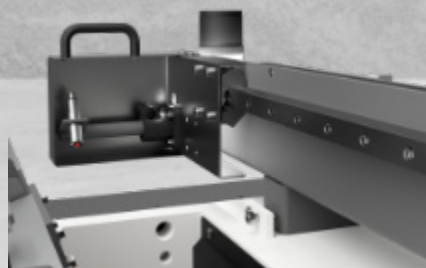

FRONT BUMPER

Item No.	Item	Info
10.I0014.0001	Bumper, Front	XP, XD, X

TRAILING GAS NOZZLE

Item No.	Item	Info
10.0016.0001	3 zone nozzle	TIG, 300A
10.0016.0002	5 zone nozzle	TIG, 300A
10.0016.0003	3 zone nozzle	TIG, 200A
10.0016.0004	5 zone nozzle	TIG, 200A
10.0016.0005	3 zone nozzle	TIG, 400A
10.0016.0006	5 zone nozzle	TIG, 400A
10.0016.0007	3 zone nozzle	Plasma
10.0016.0008	5 zone nozzle	Plasma
10.0016.0009	Double 3 zone nozzle	TIG, 300A
10.0016.0010	Double 3 zone nozzle	TIG, 200A
10.0016.0011	Double 3 zone nozzle	TIG, 400A
10.0016.0012	Double 3 zone nozzle	Plasma



OPERATOR STATION

Item No.	Item	Info
10.0018.0001	HMI mobile station	Rollable
10.0018.0002	Second Footpedal	Additional
10.0018.0003	Additional operating station	E-Stop, 2nd footpedal



LED TECHNICS

Item No.	Item	Info
10.0019.0001	Machinelamp LED	10 W
10.0019.0003	Signal Tower - Smart Light	RGBW

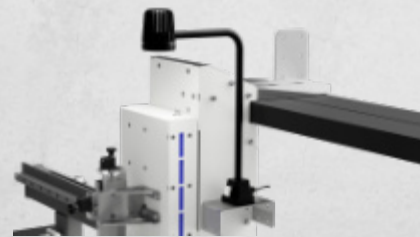
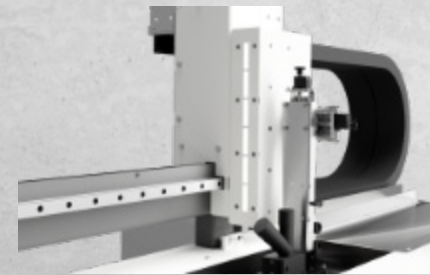
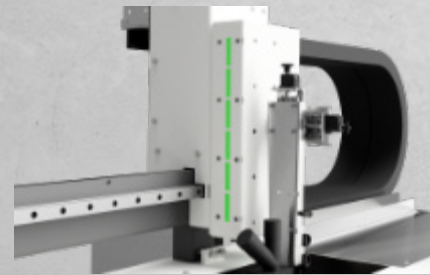

PART STOP, MOVABLE

Item No.	Item	Info
11.length.0451	Part Stop	movable

GAS SETTINGS

Item No.	Item	Info
10.0020.0001	Rotameter - AR - L/min	Europe
10.0020.0002	Rotameter - AR - L/min	US
10.0020.0003	Rotameter - AR - L/min	Asia
10.0020.0004	Rotameter - AR - L/min	South America
10.0020.0005	Rotameter - AR/H2 - L/min	Europe
10.0020.0006	Rotameter - AR/H2 - L/min	US
10.0020.0007	Rotameter - AR/H2 - L/min	Asia
10.0020.0008	Rotameter - AR/H2 - L/min	South America
10.0020.0010	Flowmeter Digital	SMC I/O
10.0020.0011	Mass Flow Control	Bürkert
10.0020.0012	Gas switch	Digital



SOFTWARE OPTIONS

SOFTWARE BUNDELS

Item No.	Item	Info
10.7000.0001	Advanced Adjustments	add more parameters
10.7000.0002	Simple Set Up	Set up support
10.7000.0003	Advanced Store	extened store and assits
10.7000.0004	Dashboard Monitoring	OEE, Process
10.7000.0006	Remote Access	OPC, Remote Connection, Smart Server

LANGUAGE PACK

Item No.	Item	Info
10.7000.1000	Language Pack - WEST	DE, EN, ES, PT, IT, FR
10.7000.2000	Language Pack - EAST	DE, EN, CZ, RU, TR,

WELDING OPTIONS

TIG DC

Item No.	Item	Info
10.5000.0001	FRONIUS TransTig 800	80 A
10.5000.0005	FRONIUS TransTig 2200	220 A
10.5000.0009	FRONIUS TransTig 2500	250 A
10.5000.0013	FRONIUS TransTig 3000	300 A
10.5000.0017	FRONIUS TransTig 4000	400 A
10.5000.0045	LORCH T 180 DC	180 A
10.5000.0049	LORCH T 220 DC	220 A
10.5000.0041	LORCH V30 mobil DC	300 A
10.5000.0053	EWM Tetrix 352 DC	TIG, 300A

TIG AC/DC

Item No.	Item	Info
10.5000.0101	FRONIUS MagicWave 2200	220 A
10.5000.0105	FRONIUS MagicWave 2500	250 A
10.5000.0109	FRONIUS MagicWave 3000	300 A
10.5000.0113	FRONIUS MagicWave 4000	400 A
10.5000.0137	LORCH T 180 AC/DC	180 A
10.5000.0141	LORCH T 220 AC/DC	220 A
10.5000.0133	LORCH V30 mobil AC/DC	300 A
10.5000.0145	EWM Tetrix 352 AC/DC	TIG, 300A

PLASMA DC

Item No.	Item	Info
10.5000.1001	FRONIUS TT 2200 PM10	220 A
10.5000.1005	FRONIUS TT 3000 PM10	300 A
10.5000.1017	MIG-O-MAT PlasmaJET 250	250 A

PLASMA AC/DC

Item No.	Item	Info
10.5000.1101	FRONIUS MW 2200 PM10	220 A
10.5000.1105	FRONIUS MW 3000 PM10	300 A

TORCH COOLING

Item No.	Item	Info
10.5000.5001	FRONIUS FK 2200	TT/MW 2200
10.5000.5002	FRONIUS FK 2500	TT/MW 2500 - 3000
10.5000.5005	LORCH WUK 7	T180 -220
10.5000.5006	LORCH WUK 5	V30
10.5000.5007	FRONIUS FK 4000	TT/MW 4000 - 5000

ADDITIONALS

WATER CHILLER UNIT

Item No.	Item	Info
10.4000.0001	HYFRA eChilly 1 CE	max. 300A
10.4000.0002	HYFRA eChilly 2 CE	max. 500A
10.4000.0004	Pfannenbergr RACK 1000 UL	max. 300A

WELD FUME EXTRACTION

Item No.	Item	Info
10.4100.0001	TEKA Handycart	movable
10.4100.0002	FUMATOR	movable
10.4100.0003	Preparation Pack	movable

WELDING MONITORING SYSTEM

Item No.	Item	Info
10.4200.0001	HKS WeldQAS	TIG
10.4200.0002	HKS WeldQAS	TIG KD
10.4200.0003	HKS WeldQAS	Plasma
10.4200.0004	HKS WeldQAS	Plasma KD

CAM TECHNOLOGY

Item No.	Item	Info
10.4300.0001	FRONIUS ArcView SINGEL	Welding camera
10.4300.0002	POLYTEC Crosshair generator	Adjusting cam

HANDLING SYSTEM

Item No.	Item	Info
10.4400.0001	Insertion Aid	Roller track 600
10.4400.0002	Insertion Aid	Roller track 800
10.4400.0003	Insertion Aid	Roller track 1000
10.4400.0004	Insertion Aid	Roller track 1200
10.4400.0005	Insertion Aid	Roller track 1400
10.4400.0006	Insertion Aid	Roller track 1600
10.4400.0012	Insertion Trolley manuel	L 500
10.4400.0013	Insertion Trolley manuel	L 1100
10.4400.0014	Insertion Trolley electric (Battery)	L 500
10.4400.0015	Insertion Trolley electric (Battery)	L 1100

ELECTRIC COMPONENTS

Item No.	Item	Info
10.4500.0001	Barcode Scanner	Parameter Loading
10.4500.0002	Air Condition - Electric cabinet	35°C +
10.4500.0004	Ethernet Connection box	Fiber Cabel

ADDITIONAL KITS

Item No.	Item	Info
10.4700.0001	Welding Starter Kit TIG	ABITIG MT 300 W
10.4700.0002	Welding Starter Kit TIG	ABITIG MT 260 W
10.4700.0003	Welding Starter Kit TIG	TTW 4500
10.4700.0004	Welding Starter Kit Plasma	PTW 3500
10.4700.0005	Welding Starter Kit Plasma	PJB 250
10.4700.0016	ToolKit	Start Up / Set Up

SERVICE & CARE

PACKAGING

Item No.	Item	Info
10.8000.0001	Wooden pallett	Truck transport only
10.8000.0007	Wooden Box Sea	for Seafare
10.8000.0013	Wooden Box Air	for Land and Airfare

TRAINING

Item No.	Item	Info
10.8100.0001	StartUp & Training Package	2 D on side incl. travel
10.8100.0004	Endacceptance Package	3 D on side incl. travel

TRANSPORT (Incoterms® 2020)

Item No.	Item	Info
10.8200.0001	FCA	Schnelldorf
10.8200.0006	FCA	DE
10.8200.0011	FCA	EU
10.8200.0021	DAP	DE
10.8200.0026	DAP	EU

CARE

Item No.	Item	Info
10.8300.0002	Sparepart package small	Pneumatics, Sensors
10.8300.0005	Sparepart package full	Pneumatics, Sensors, PLC
10.8300.0008	Service Contract - 1 Year	X-Series
10.8300.0010	Service Contract - 2 Year	X-Series
10.8300.0013	Warrenty Extention 24 Month	X-Series

X SERIES



Schnelldorfer Maschinenbau GmbH

Kappelweg 6 | 91625 Schnelldorf | GERMANY

info@schnelldorfer-maschinenbau.de | +49 (0) 7950 9889 - 0



#PartOfPerfectWeldTechnology