

X SERIES

Product catalogue 2022

Longitudinal seam welding machines

LINEARWELD XL INEX



CONTENT	2
OVERVIEW	4
GENERATION neXt	6
DASHBOARD MONITORING	8
SIMPLE SET UP	10
ADVANCED STORE	12
ADVANCED ADJUSTMENTS	14
REMOTE ACCESS	16
LINEARWELD XL INEX	18
XL INEX - WELDING	20
XL INEX - BENEFITS	22
XL INEX - TECHNICAL SPECIFICATIONS	28
XL INEX - ITEMS	30
NOTES	46

Legal notice

Publisher:

Schnelldorfer Maschinenbau GmbH
 Kappelweg 6
 91625 Schnelldorf
 Germany

Telephone +49 (0) 7950 9889-0
 Fax +49 (0) 7950 9889-29

info@schnelldorfer-maschinenbau.de
 www.schnelldorfer-maschinenbau.de

Name of document:



Product catalogue 2022 - Longitudinal seam welding machine - LINEARWELD XL INEX V1.1 EN

Copyright:

© Schnelldorfer Maschinenbau GmbH
 Passing on and reproduction of this document and the use or disclosure of its contents are prohibited if not explicitly permitted. Any breach or infringement will result in liability for damages. All rights created by patent grant or registration of a utility model or design patent are reserved.

LINEARWELD **XP**



Aerospace- and Bellow industry
Automotive industry
Chimney systems

	00,15 mm - 00,80 mm
	250 mm - 1000 mm
	15 mm - 1050 mm*

LINEARWELD **XD**

LINEARWELD **X**



Aerospace- and Bellow industry
Automotive industry
Tank and Equipment manufacturing
Food technology and kitchen makers
HAVC industry
Vessel construction
Chimney systems

	00,20 mm - 03,00 mm
	200 mm - 1600 mm
	25 mm - 1050 mm*

LINEARWELD **XL** EXTL

LINEARWELD **XL** INEX

Expansionjoint industry
Automotive industry
Tank and Equipment manufacturing
Food technology
HAVC Industry
Construction of machines and housings
Vessel construction
Ducts

	00,50 mm - 15,00 mm
	600 mm - 4100 mm
	80 mm - 1100 mm*

LINEARWELD **XLS** EXTL

LINEARWELD **XLS** INEX

Expansionjoint industry
Tank and Equipment manufacturing
Food technology
HAVC Industry
Construction of machines and housings
Vessel construction
Ducts

	00,50 mm - 15,00 mm
	1600 mm - 4100 mm
	145 mm - 5190 mm

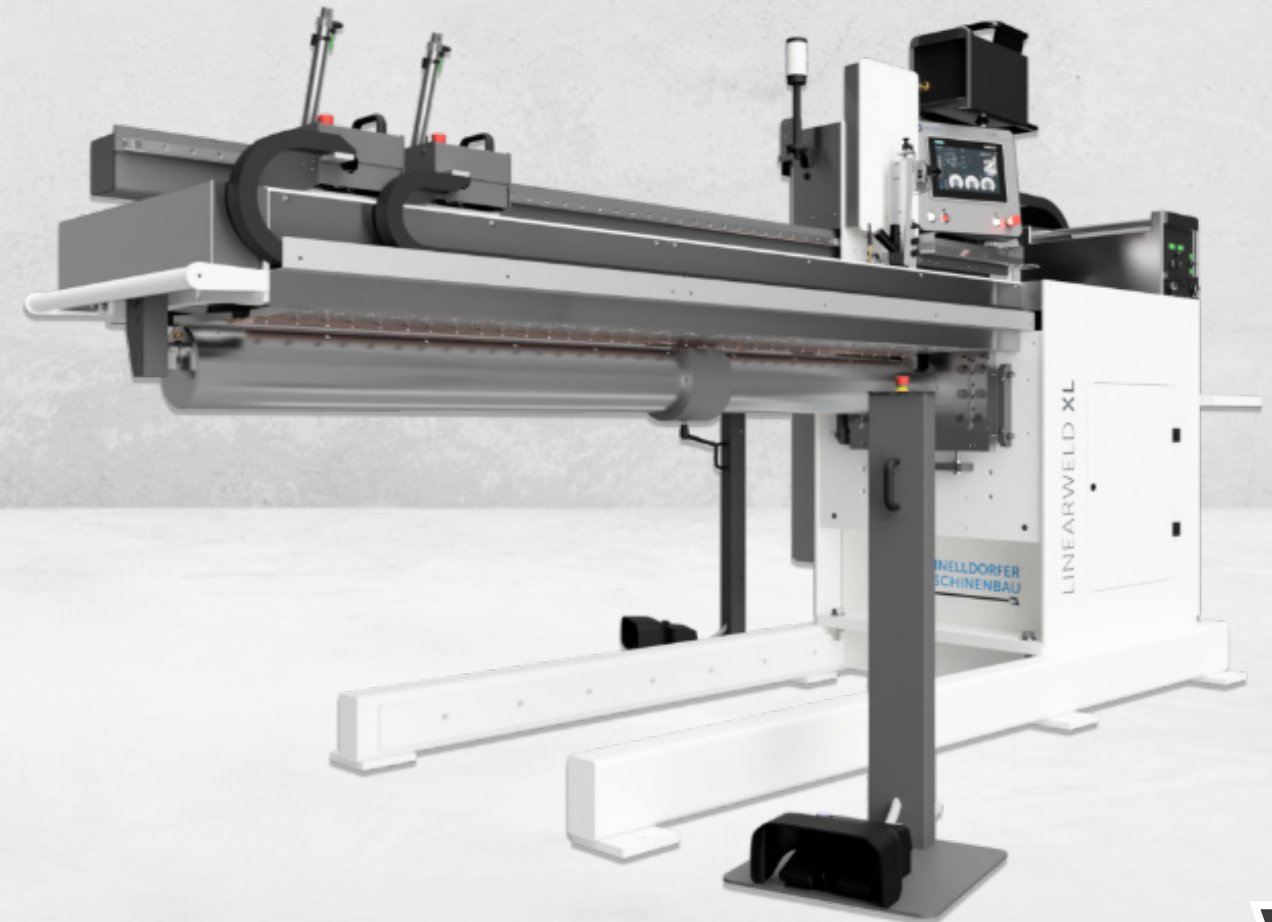
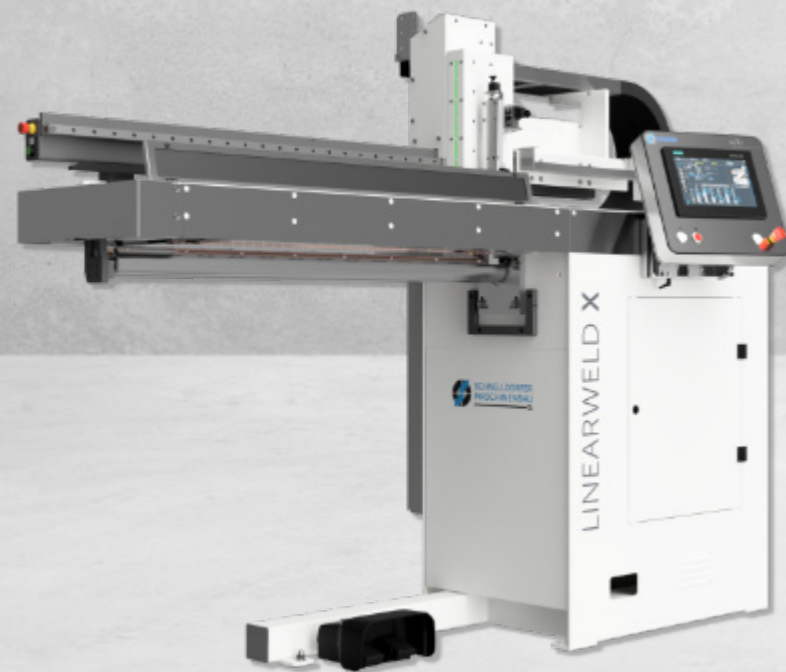





* With standard machine body, bigger diameters possible with hightening elements (option)

Revolutionizes welding automation

Now, there is a brand new machine control which offers you all possibilities of the 21th century and makes you ready for **industry 4.0**

The **neXt** machine control is part of our seam welding machines made in Germany. Intelligent I/O sensor technology, state of the art machine plc control, smart and intuitive Human Machine Interface and full IOT connectivity takes your production to the neXt level!

 <p>INDUSTRY 4.0</p> <ul style="list-style-type: none"> • Industry 4.0 ready • OPC UA connection • OEE Monitoring • Remote Access 	 <p>EFFICIENCY</p> <ul style="list-style-type: none"> • High reduction of intermediate times • AI assistance systems for faster start up • Operator guidance for more efficiency 	 <p>TPM</p> <ul style="list-style-type: none"> • Constantly actuators check up • Downtime warnings • Reminder message connected via OPC UA 	 <p>TRAINING</p> <ul style="list-style-type: none"> • Intuitive HMI user guide • All functions and buttons visualized with icons • Assistance button on each side 	 <p>PRODUCTION</p> <ul style="list-style-type: none"> • Quality improvement through self-examination • Set Up assistance with show it videos
---	---	---	--	--



OPC UA

IO-Link

WiFi

USB



INDUSTRY 4.0



- Video guided machine control
- Intelligent setting control
- Parameter assistant
- Set Up slide shows
- Visualized error message
- Dashboard selection
- App gallery
- Ready for industry 4.0

Program faster and reduce non-productive times!

Simplify complex processes and make them intuitive to use, this is a challenge that we are always happy to face!

We are sure that this new control concept will exceed all expectations and lift the operator experience into completely new spheres.



VISUALIZATION

100 %

- Intuitiv haptics with full visualized process guidance
- Super high quality look & feel



OEE Monitoring App realtime calculation,

2/14/2020, 1:13:09 AM Production Name: soft1

Actors: [Icons]

Position: 476.25 mm 0.00 mm/s

Options: [Icons]

Pressure: Front 0.000 bar Rear 0.000 bar

State: [Icons]

Quality: 17.442 %

Current [A] 127.9

X-Axis [mm...sec] 126.7

X-Axis [mm...sec] 47.3

Coldwire [cm...min] 127.9

Coldwire [cm...min] 72.7

Pulse [Hz] 127.9

Produce more efficiently!

With the software bundel - Simple Set Up - you can increase the efficiency of your production enormously.

Developed for a "one piece flow" production and the requirements of "Total Productive Maintenance", the machine supports the operator as well as the planning.



PERFORMANCE

290 %

- More PLC Control performance
- I/O Link - intelligent sensorics
- ProfiNET

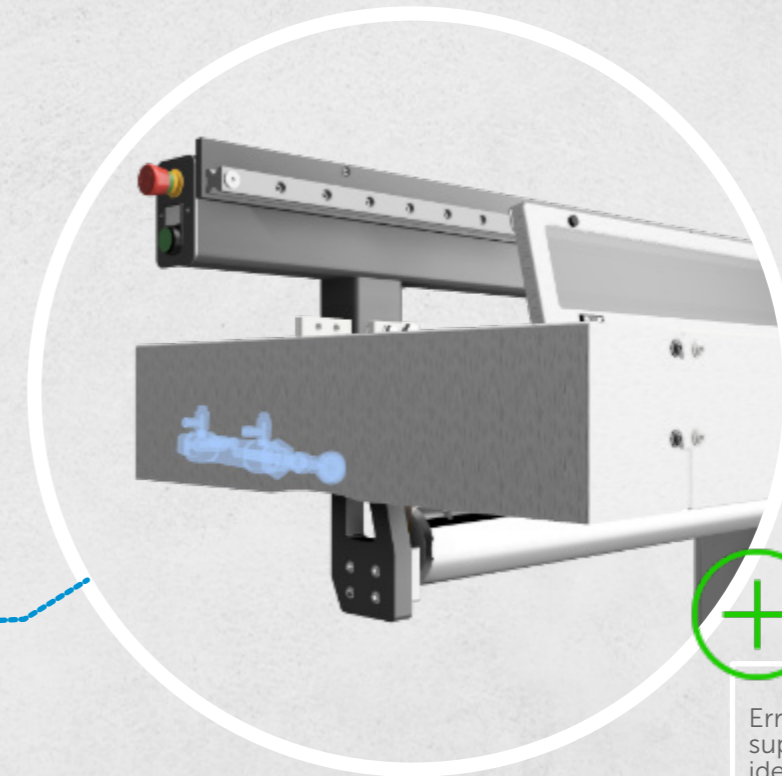

Error and warning messages, visually supported for quick and clear identification

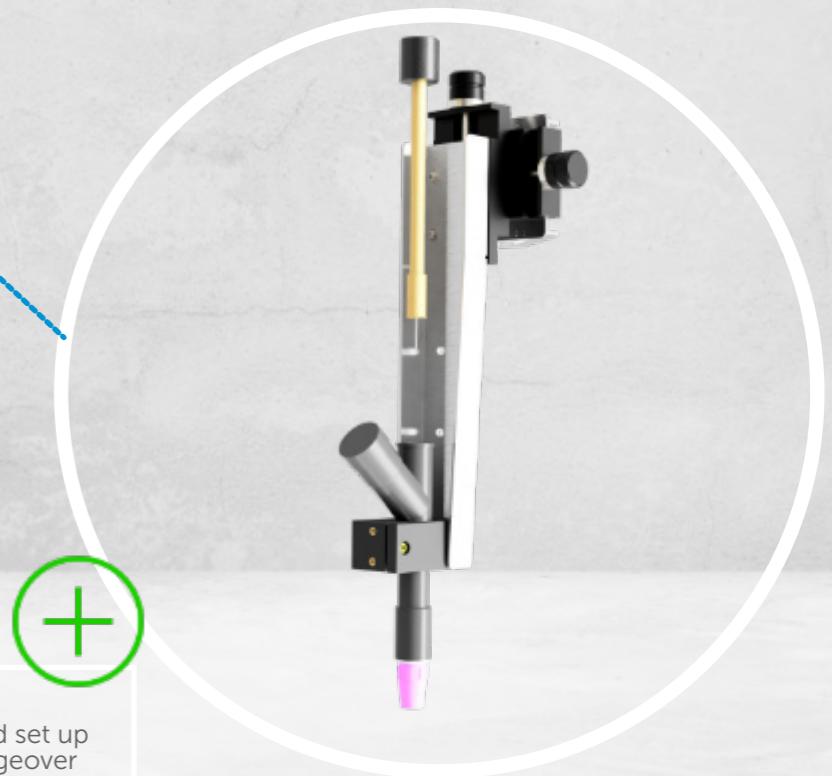

Slide show video supported set up for a fast and reliable changeover

Stay in the loop!

The challenge of producing ever-smaller series with utmost flexibility can often result in a hectic working space and time pressure. This also increases the risk of errors. Using the software bundle - ADVANCED STORE, you can take steps to address this by making your order management transparent. This option enables you to control your production and manage all production orders. As a result, you avoid errors and delays while staying in the loop at all times.



DATA STORE

400 %

- More storage space and performance
- Brand new product-catalogue function
- Online / offline compare function



Pre installed Parameter Database, for a wide range of different materials and thicknesses



Parameter upload by Data code reader

Improve your quality!

Automatic welding is high-tech teamwork of various system components. Only when they work together perfectly, there are outstanding welding results of high economic efficiency guaranteed. It always comes on the detail - from the transport of the components to the ignition of the arc.

The intelligent and precise interaction of all modules involved in the welding process guarantees the constant and always reproducible quality of the weld seams.



Plausibility control function helps you to set up the machine always right



Direct access for main setting in the Dashboard function





FUNCTIONS

33 %

- More Adjustment possibilities and parameters available
- Plausibility control function
- Simulation mode

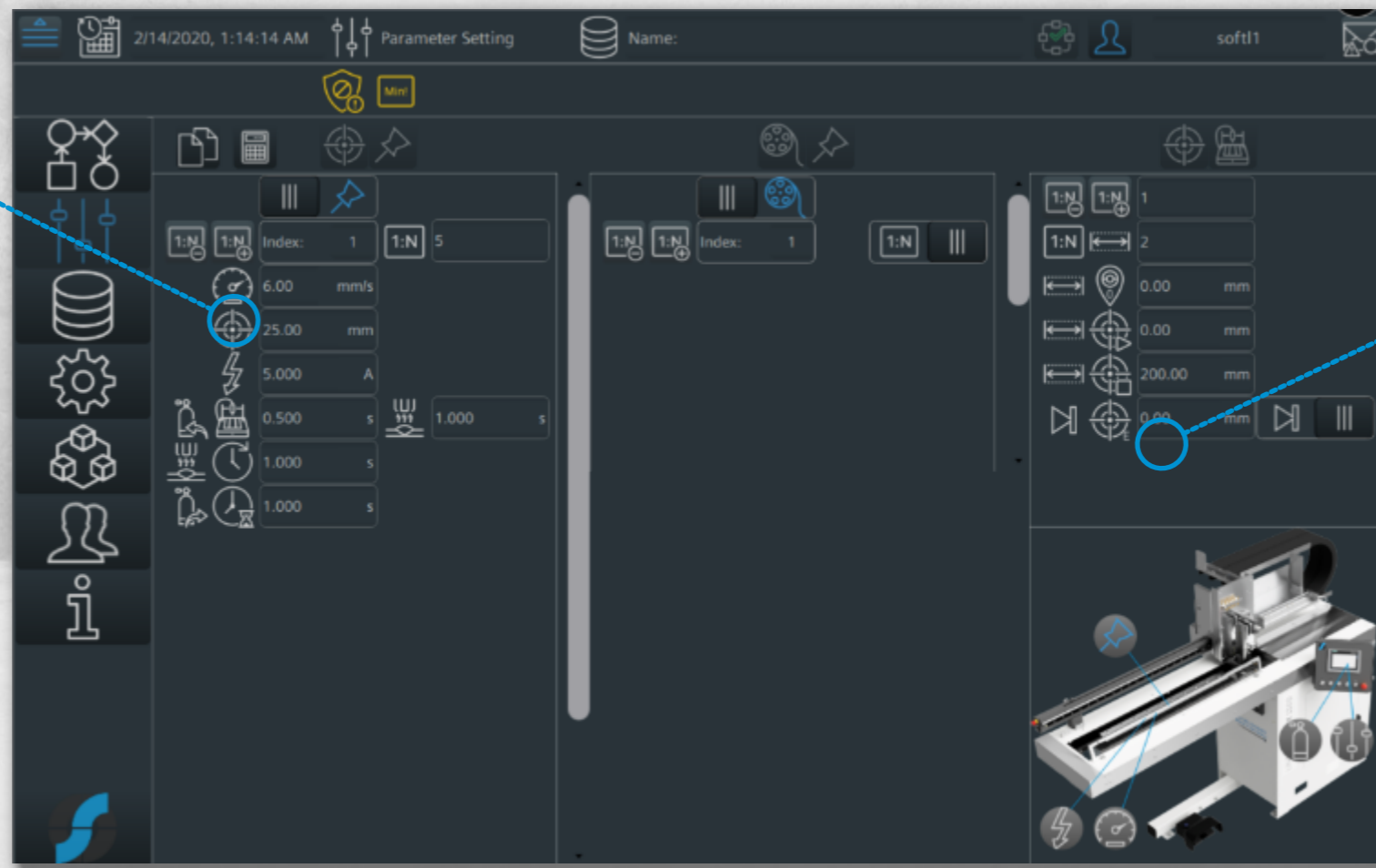

Always keep an eye on the production processes. At any time. From everywhere.

With the software bundle - Remote Access, you have full connectivity, monitoring and analysis. In this way you avoid machine and production downtimes and create maximum transparency



INDUSTRY 4.0

100 %

- Ready for industry 4.0
- OPC UA Server & Client mode
- AI (artificial intelligence) Parameter controle

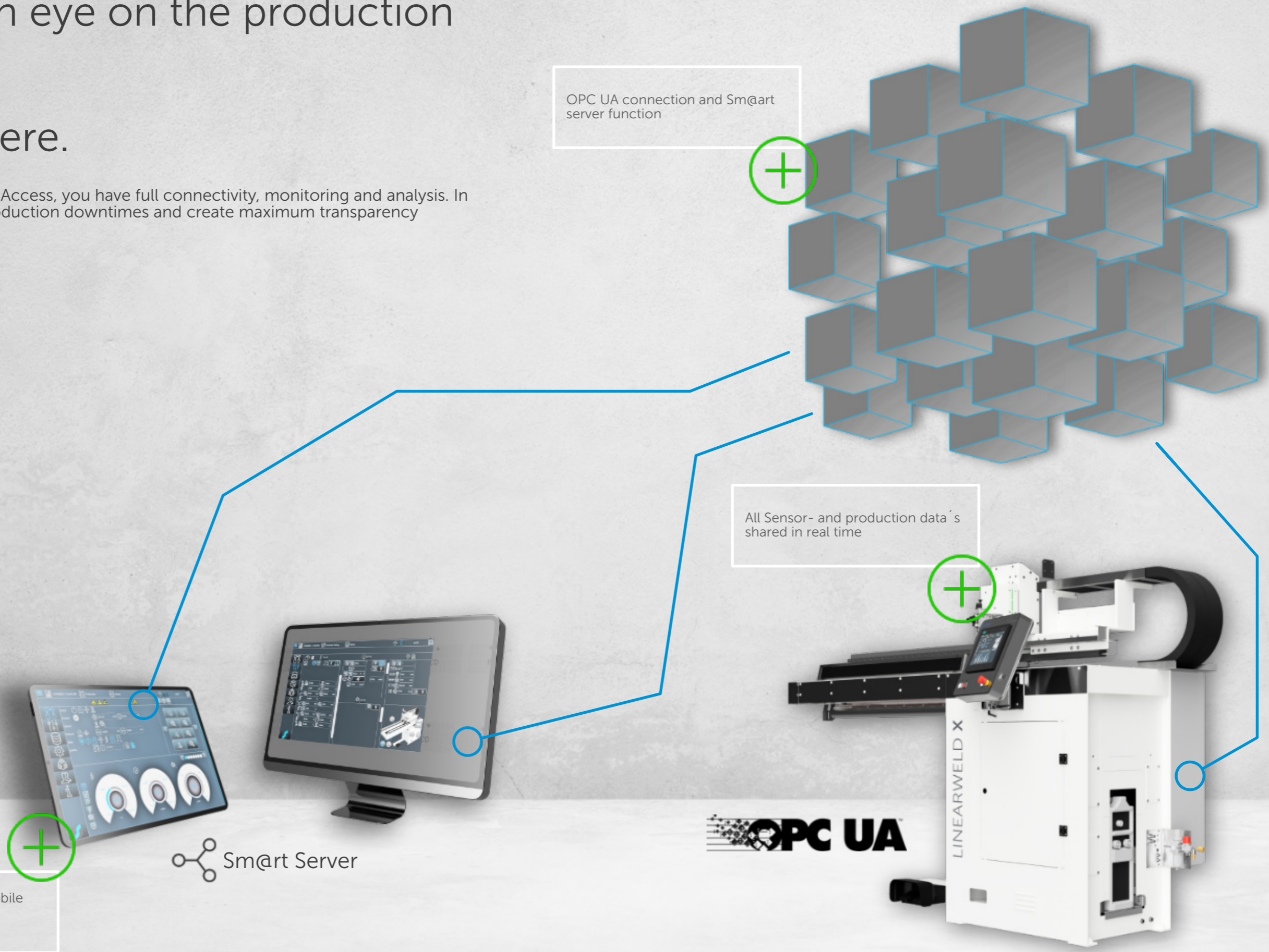

Xtra Large in welding automation

High quality and productive longitudinal seam welding requires the use of **advanced and superior technologies**. This enables us to protect and expand our market position.

Our LINEARWELD XL-Series longitudinal seam welding machines offer **unsurpassed technology** for **welding metallic longitudinal seams**.

The **XL INEX** series is an **absolute all-rounder** and stands for the **highest quality with maximum robustness**. Designed for the highest loads, the LINEARWELD XL INEX offer the **platform for all welding requirements**.

Their specially developed clamping system in combination with the most modern production processes enables sheet metal thicknesses of up to 15 mm to be joined from the inside and outside.

The LINEARWELD machine type is characterized by the **best quality, simple operation and high speeds**.

Available in various welding lengths from 2100 mm to 4100 mm, the highly modular system with many equipment variants enables quick adaptation to **your individual needs**.



00,50 mm - 15,00 mm



2100 mm - 4100 mm



Outside welding :
225 mm* - 1080 mm**

Inside welding :
from 1600 mm



Stainless Steel | Mild Steel |
Carbon Steel | Galvanized
Steel | Aluminium | Titanium |
Copper

+ HIGHEST PRECISION FOR PERFECT WELDING

- Ergonomic design
- Weld seams with no discolouration
- Welding without deformation of the workpiece
- High reproducibility
- Precise torch motion
- Highest quality welding results
- Quick-change system for the backing track
- Intuitive user interface with clear program management
- High-grade components



* With standard T-Frame Mandrel, smaller diameters possible with round mandrels (option)

** With standard machine body, bigger diameters possible with hightening elements (option)

Perfect welds from the first part

This helps improving the quality of your products as well, particularly if you are interested in a professional design.
The increased quality level of your products strengthens your image, justifies higher prices and thus improves your chances on the market

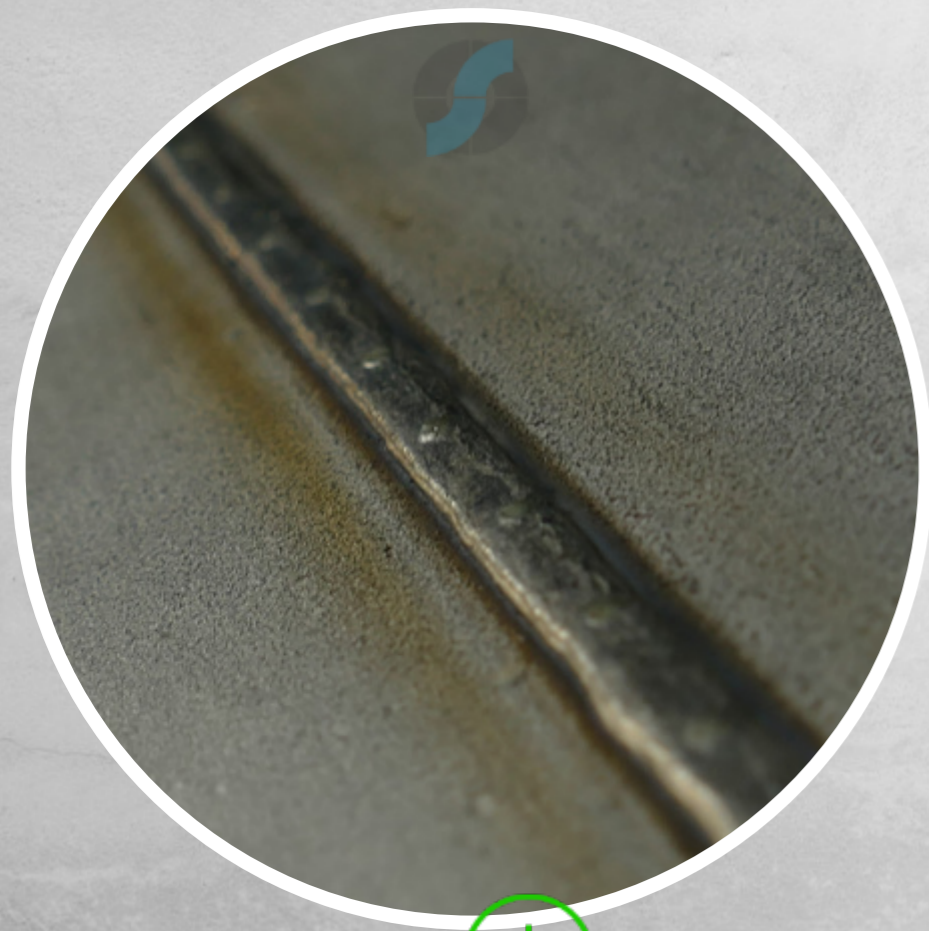

Stainless Steel Vessel
T: 5,0 mm (welding seam root)
MIG/MAG (GMAW)



Stainless Steel Tank
T: 10 mm
Plasma Keyhole

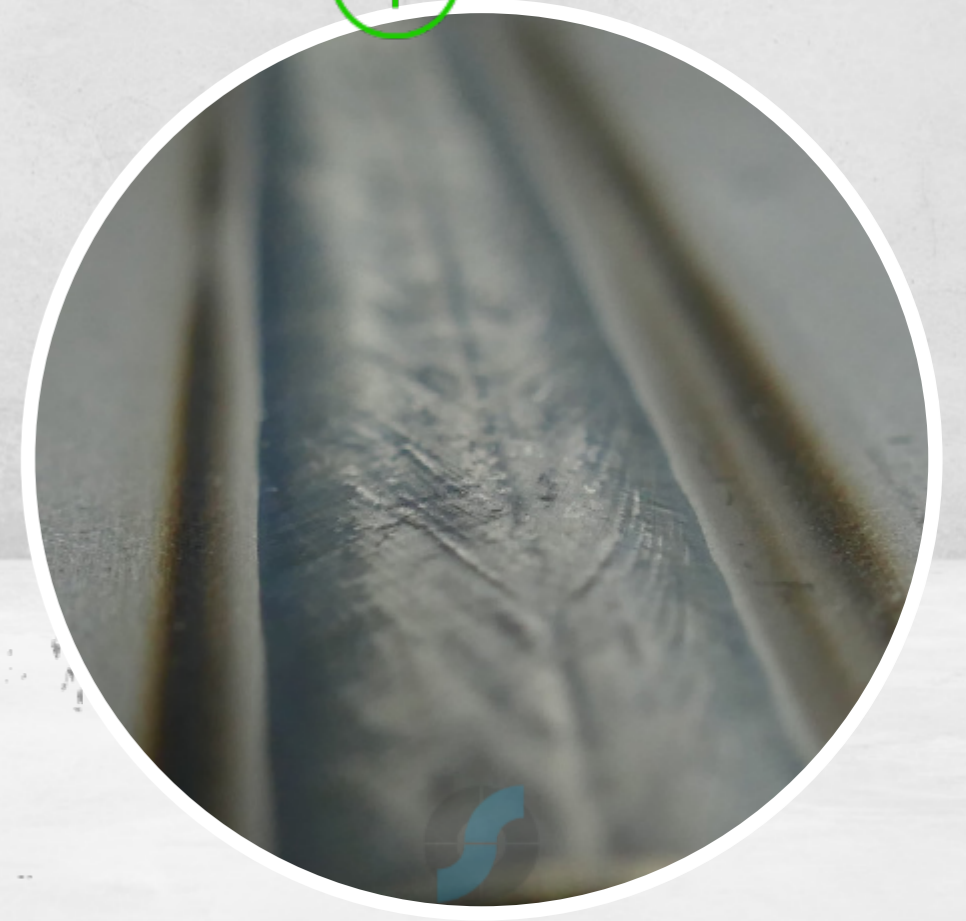
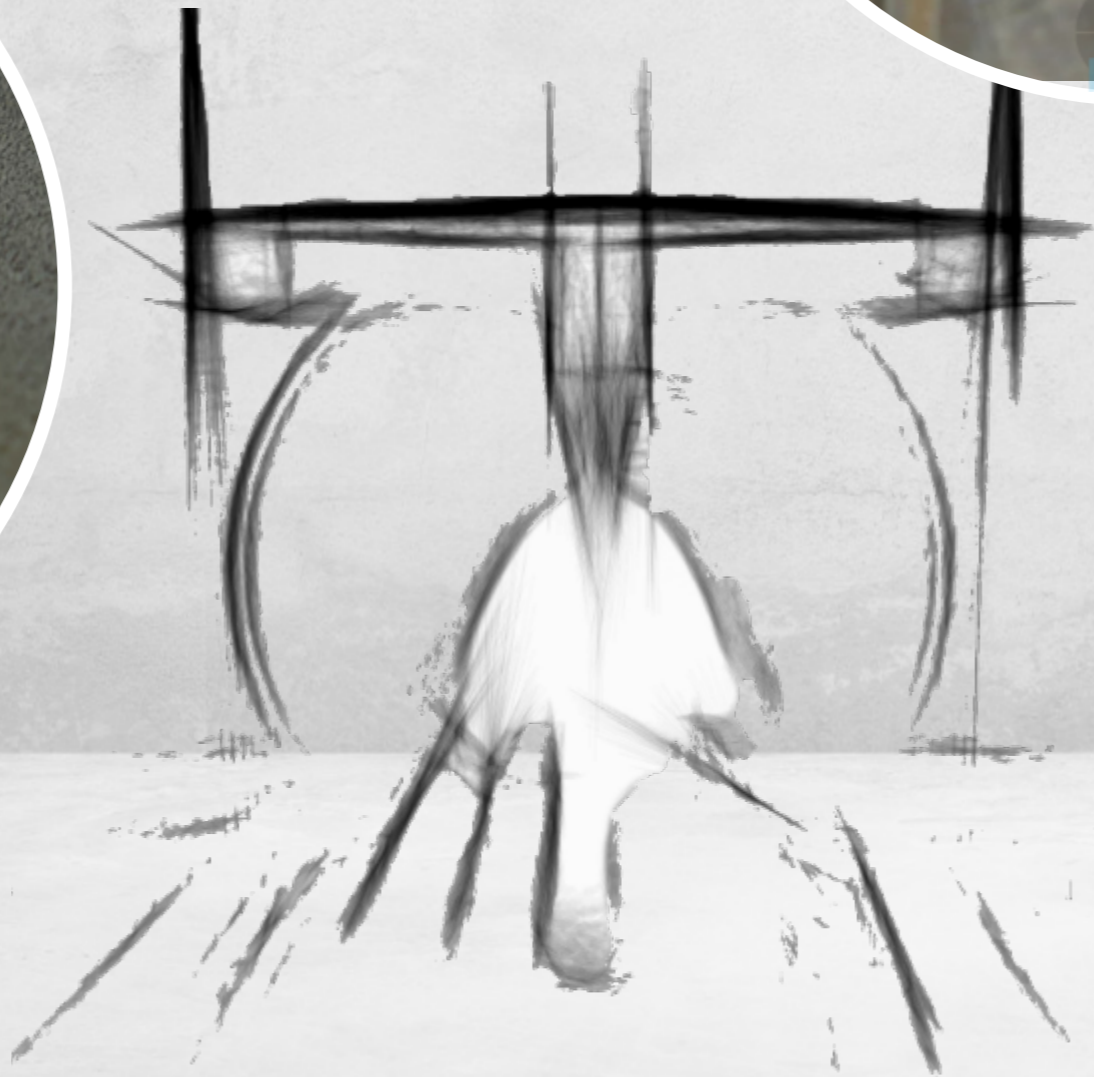

Stainless Steel vessel
T: 6,0 mm
High Performance TIG (inFocus)

Ready to weld!



Minimal distortion of welded parts



Utilisation of all common welding processes



Wide range of control options



Easy to use



Increased welding speed



Reducing of overall cycle time

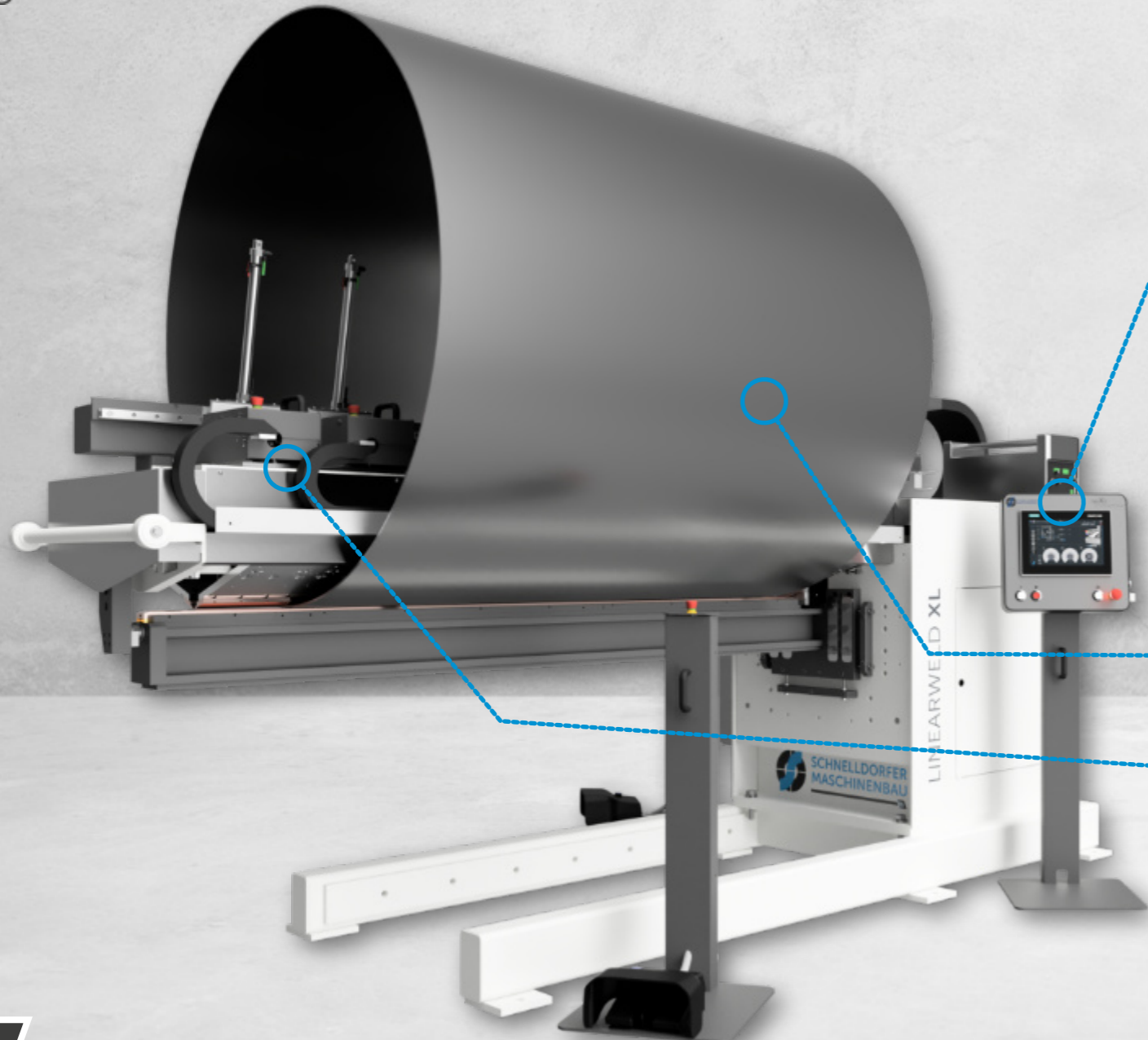

SIEMENS UNIFIED HMI
Equipped with the best welding automation software on the market



Torch support with counter in combination with Touch & Signal software function makes tungsten setting 100% reliable and easy



High precision center stop and pre clamp function, for the fastest and most comfortable insertion of the parts

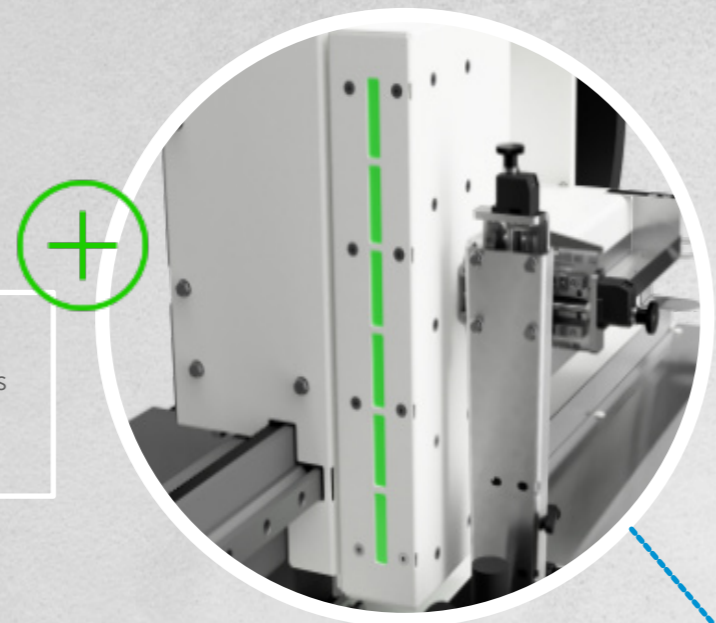

Signal Tower - Smart Light this element always shows the status of the machine and illuminates the welding area during setup

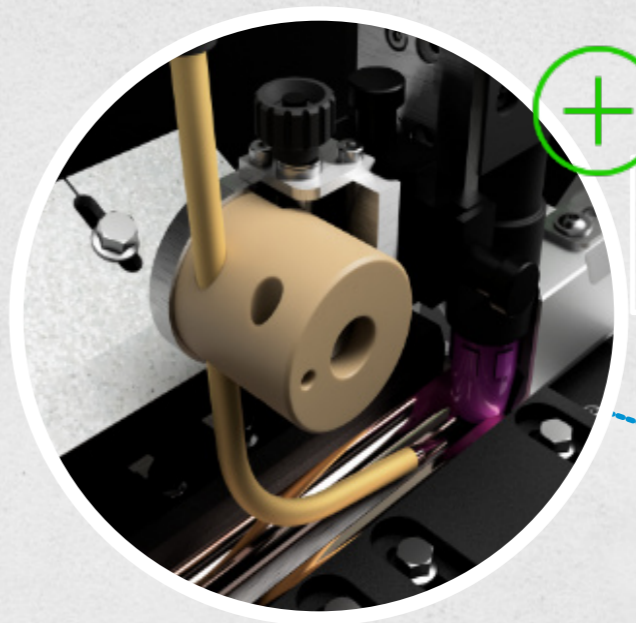

Cold wire feed unit with 3-axis adjustment, for the precise feeding of additional cold wire

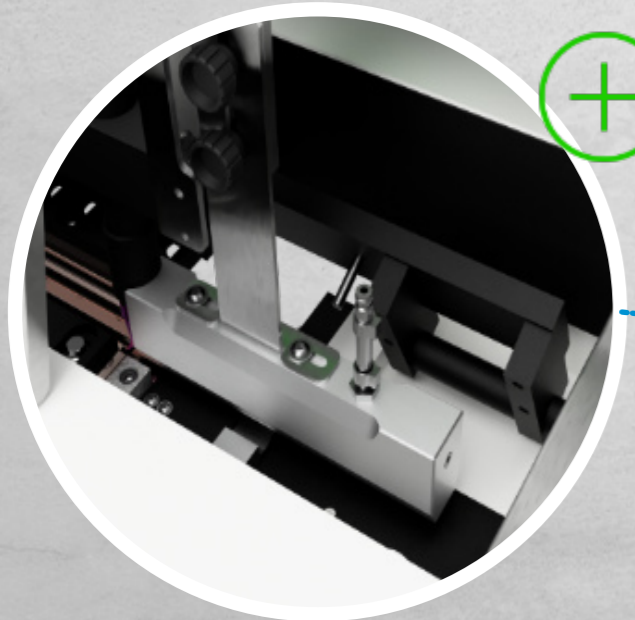

Fold-out trailing gas nozzle in a special design for absolutely astonishing welding results



Specially developed mandrel design with quickly exchangeable backing bar and sandwich cooling line

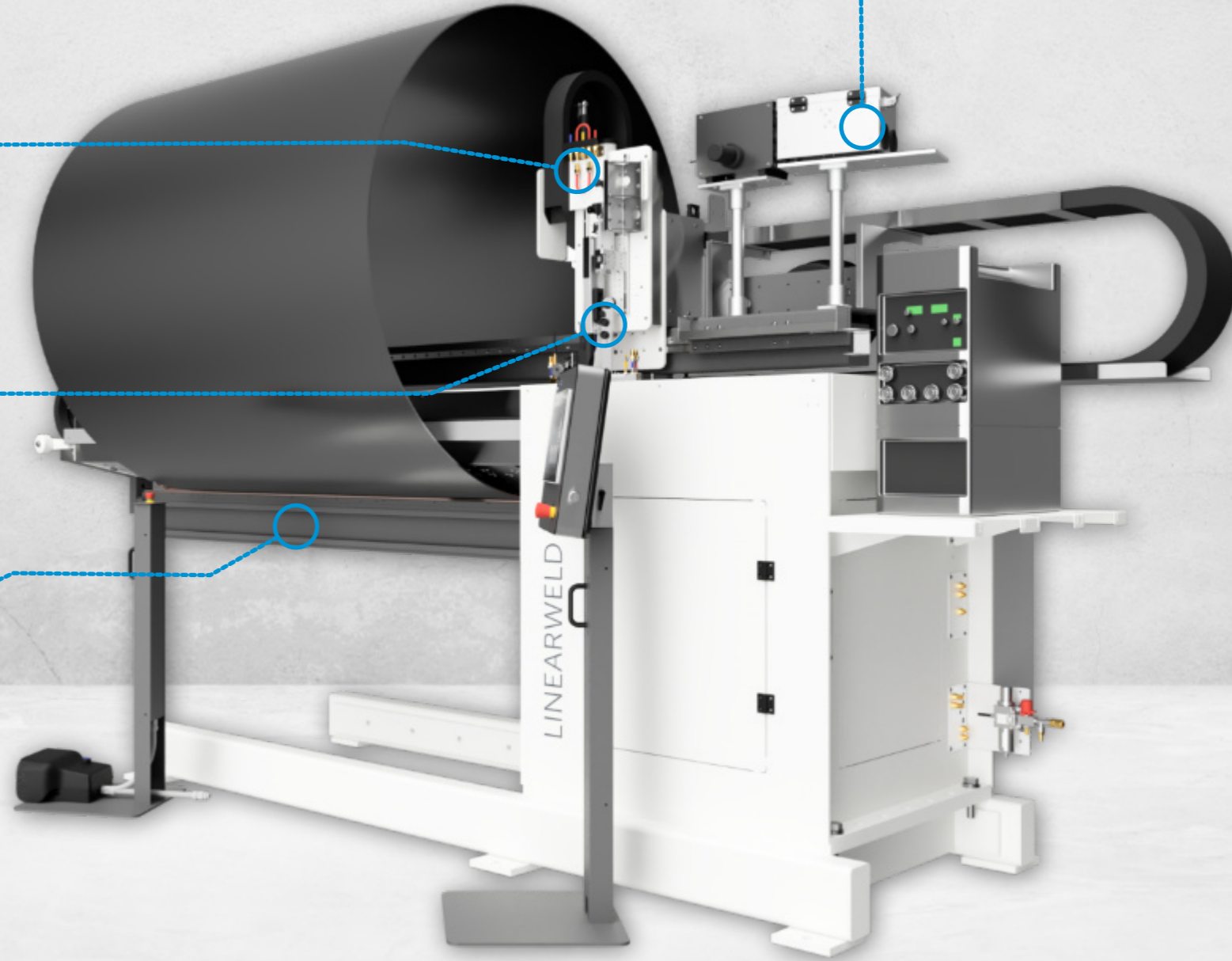

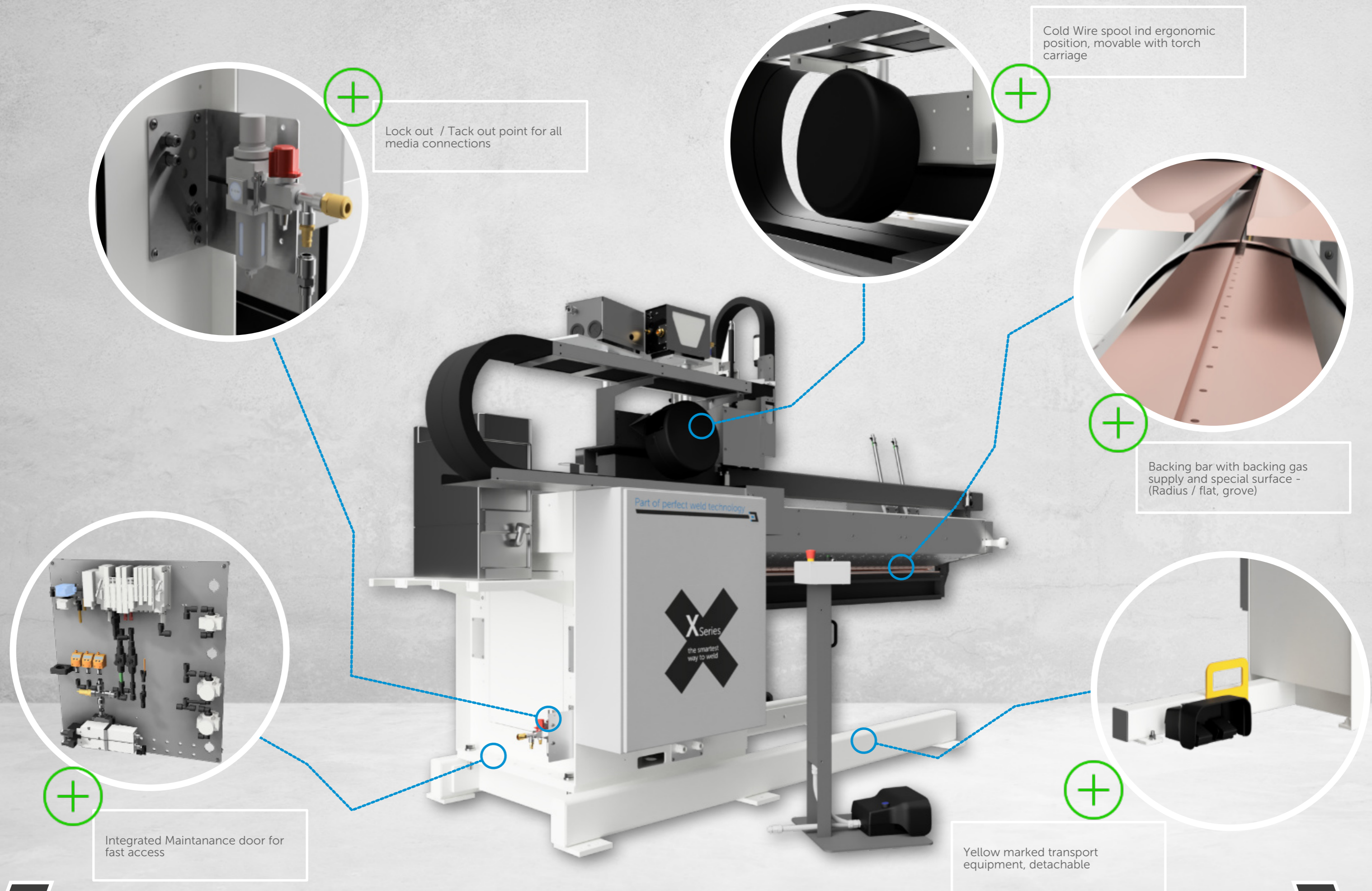

+ Lock out / Tack out point for all media connections

+ Cold Wire spool in ergonomic position, movable with torch carriage

+ Backing bar with backing gas supply and special surface - (Radius / flat, groove)

+ Yellow marked transport equipment, detachable

+ Integrated Maintenance door for fast access

LINEARWELD XL INEX	2100	2600	3100	3600	4100
Max. welding length [mm]	2120	2620	3120	3620	4120
Min. Diameter (inside) [mm]	225*	260*	305*	355*	385*
Max Diameter (outside) [mm]	1050 mm (optional heightening elements . +250 / +500 / +750 / +1000)				
Material type	Stainless Steel, Mild Steel, Carbon Steel, Galvanized Steel, Aluminium, Titanium				
Material thickness [mm]	00,20 mm - 03,00 mm				
Backing bar	Sandwich technology, changable without any media connection, fast exchange fixure				
Clamping system	Pneumatic, Pre-clamp feature				
Arc Length	Constant , over whole welding length (tolerances of 0,05 mm)				
Mandrel lock	Pneumatic, position controlled				
Welding process	TIG, High performance TIG, Micro & Softplasma				
Welding direction	free selectable				
Gas	Torch Gas, Backing Gas, Trailing Gas, Clamping finger gas (option)				
Cooling Circuit	Mandrel / Backing bar, Torch				
Colour	Traffic White - RAL 9016 (powder coated, matt, structure) & Slate Grey - RAL 7015				
Control	Siemens S7-1515				
Operator Panel	SIEMENS SINAMIC - Unified Comfort Panel				
Motor	SIEMENS SINAMIC - S210 Servo motor				
Welding Interface	ProfiBus / ProfiNet				
Standard	CE-Mark / UL-prepared				
Electric Supply	400/230 Volt / 3 / N / PE; 50/60 Hz; TN-grid				
Air Supply	6 bar, dry, filtered				
Ambient Temperature	+ 10°C to + 35°C				

* With standard T-Frame Mandrel, smaller diameters possible with round mandrels (option)

MACHINES



LINEARWELD XL INEX

Item No.	Item	Info
15.2100.0000	LINEARWELD XL 2100 INEX	2100 mm welding length
15.2600.0000	LINEARWELD XL 2600 INEX	2600 mm welding length
15.3100.0000	LINEARWELD XL 3100 INEX	3100 mm welding length
15.3600.0000	LINEARWELD XL 3600 INEX	3600 mm welding length
15.4100.0000	LINEARWELD XL 4100 INEX	4100 mm welding length

FUNCTION ITEMS



MANDREL

Item No.	Item	Info
15.lenght.0001	Steel Frame Mandrel	
15.lenght.0002	Round - Mild Steel	
15.lenght.0003	Round - Stainless Steel	
15.lenght.0004	Stepped - Mild Steel	Customized on request
15.lenght.0005	Stepped - Stainless Steel	Customized on request
15.lenght.0006	Round SLIM - Mild Steel	Max. T = 5 mm (- 10 mm Ø)
15.lenght.0007	Round SLIM - Stainless Steel	Max. T = 5 mm (- 10 mm Ø)
15.lenght.0008	Round ULTRA SLIM - Mild Steel	Max. T = 3 mm (- 30 mm Ø)
15.lenght.0009	Round ULTRA SLIM - Stainless Steel	Max. T = 3 mm (- 30 mm Ø)



MANDREL BASE

Item No.	Item	Info
15.lenght.0100	Standard	Solid
15.lenght.0200	Lift	movable

HMI DISPLAY

Item No.	Item	Info
10.0010.0002	Control Panel, HMI - Touch Screen 12"	Touch

CLAMPING FINGERS

Item No.	Item	Info
10.0011.0021	200 mm UNI	CU
10.0011.0022	200 mm THIN	CU
10.0011.0023	200 mm GAS	CU
10.0011.0024	200 mm SOFT	Stainless Steel



BACKING BAR

Item No.	Item	Info
15.lenght.0011	UNI - Radius	CU (t= 0,4 mm - 2,5 mm)
15.lenght.0012	UNI - Flat	CU (t= 0,4 mm - 2,5 mm)
15.lenght.0015	SOFT - Radius	SS (t= 0,7 mm - 3,0 mm)
15.lenght.0016	SOFT - Flat	SS (t= 0,7 mm - 3,0 mm)
15.lenght.0017	STRONG - Radius	CU (t= 2,0 mm - 5,0 mm)
15.lenght.0018	STRONG - Flat	CU (t= 2,0 mm - 5,0 mm)
15.lenght.0019	CLEAN - Radius	CU (t= 0,7 mm - 2,0 mm)
15.lenght.0020	CLEAN - Flat	CU (t= 0,7 mm - 2,0 mm)
15.lenght.0021	HEAVY DUTY - Radius	CU (t= 5,0 mm - 12,0 mm)
15.lenght.0022	HEAVY DUTY - Flat	CU (t= 5,0 mm - 12,0 mm)

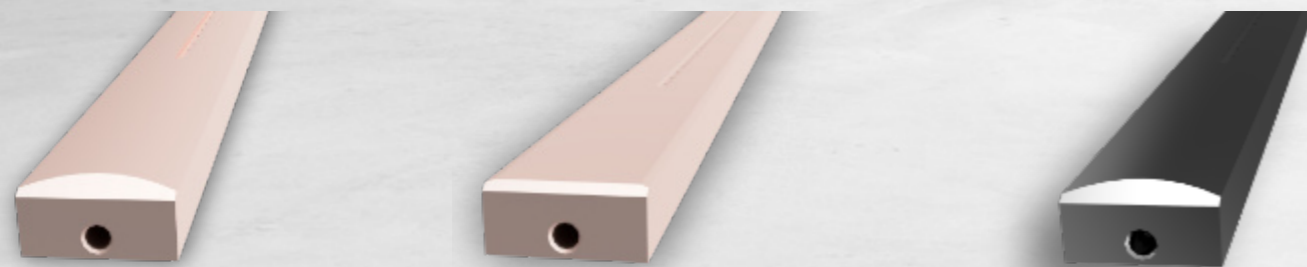

TORCH LIFT

Item No.	Item	Info
10.0012.0001	Standard	Pneumatic
10.0012.0002	Motor	Electric
10.0012.0003	AVC (Arc Voltage Control)	Sensoric

Standard

Item No.	Item	Info
10.0013.0001	CE - Conformity (Labled)	X-Series
10.0013.0002	UL - Conform (unlabeled)	X-Series

HARDWARE OPTIONS



CENTER STOP

Item No.	Item	Info
15.lenght.0301	Standard, swiveling	Up tp 1600
15.lenght.0303	Flex, movable	From 2100

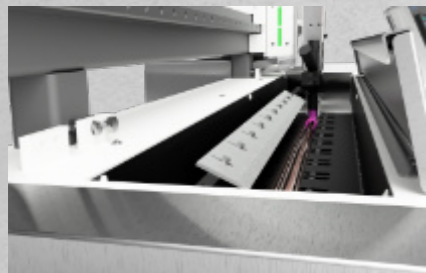

HIGHTENING ELEMENT

Item No.	Item	Info
10.0014.0250	250 mm	XP, XD, X
10.0014.0500	500 mm	XP, XD, X
10.0014.0750	750 mm	XP, XD, X
10.0014.1000	1000 mm	XP, XD, X
10.0014.1500	1500 mm	XP, XD, X

LASERPOINTER

Item No.	Item	Info
15.lenght.0310	Laserpointer	Front 6 back

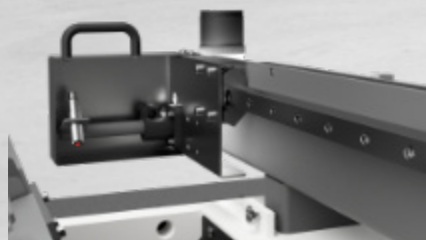

FRONT BUMPER

Item No.	Item	Info
10.I0014.0003	Bumper, Front	INEX

COLOR

Item No.	Item	Info
10.0015.0001	Standard	Traffic White & Slate Grey
10.0015.0002	Body customized	Additional - Slate Grey
10.0015.0003	Complete customizedd	RAL

TRAILING GAS NOZZLE

Item No.	Item	Info
10.0016.0001	3 zone nozzle	TIG, 300A
10.0016.0002	5 zone nozzle	TIG, 300A
10.0016.0003	3 zone nozzle	TIG, 200A
10.0016.0004	5 zone nozzle	TIG, 200A
10.0016.0005	3 zone nozzle	TIG, 400A
10.0016.0006	5 zone nozzle	TIG, 400A
10.0016.0007	3 zone nozzle	Plasma
10.0016.0008	5 zone nozzle	Plasma
10.0016.0009	Double 3 zone nozzle	TIG, 300A
10.0016.0010	Double 3 zone nozzle	TIG, 200A
10.0016.0011	Double 3 zone nozzle	TIG, 400A
10.0016.0012	Double 3 zone nozzle	Plasma
10.0016.0013	3 zone nozzle Water cooled	PTW 4500
10.0016.0014	5 zone nozzle Water cooled	PTW 4500
10.0016.0015	3 zone nozzle Water cooled	PJB 3500
10.0016.0016	5 zone nozzle Water cooled	PJB 3500

TORCH OSCILLATION UNIT

Item No.	Item	Info
10.0017.0001	Oscillation unit	Servo motor

OPERATOR STATION

Item No.	Item	Info
10.0018.0001	HMI mobile station	Rollable
10.0018.0002	Second Footpedal	Additional
10.0018.0003	Aditonal operating station	E-Stop, 2nd footpedal



LED TECHNICS

Item No.	Item	Info
10.0019.0001	Machine LED	10 W
10.0019.0003	Signal Tower - SmartLight	RGBW

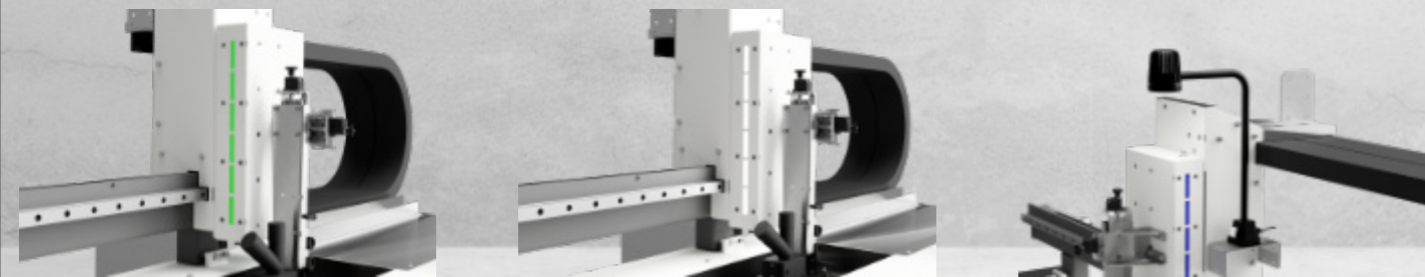

PART STOP, MOVABLE

Item No.	Item	Info
15.lenght.0451	Part Stop	movable

GAS SETTINGS

Item No.	Item	Info
10.0020.0001	Rotameter - AR - L/min	Europe
10.0020.0002	Rotameter - AR - L/min	US
10.0020.0003	Rotameter - AR - L/min	Asia
10.0020.0004	Rotameter - AR - L/min	South America
10.0020.0005	Rotameter - AR/H2 - L/min	Europe
10.0020.0006	Rotameter - AR/H2 - L/min	US
10.0020.0007	Rotameter - AR/H2 - L/min	Asia
10.0020.0008	Rotameter - AR/H2 - L/min	South America
10.0020.0010	Flowmeter Digital	SMC I/O
10.0020.0011	Mass Flow Control	Bürkert
10.0020.0012	Gas switch	Digital



SOFTWARE OPTIONS

SOFTWARE BUNDELS

Item No.	Item	Info
10.7000.0001	Advanced Adjustments	add more parameters
10.7000.0002	Simple Set Up	Set up support
10.7000.0003	Advanced Store	extened store and assits
10.7000.0004	Dashboard Monitoring	OEE, Process
10.7000.0006	Remote Access	OPC, Remote Connection, Smart Server

LANGUAGE PACK

Item No.	Item	Info
10.7000.1000	Langugage Pack - WEST	DE, EN, ES, PT, IT, FR
10.7000.2000	Language Pack - EAST	DE, EN, CZ, RU, TR,

WELDING OPTIONS

TIG DC

Item No.	Item	Info
10.5000.0001	FRONIUS TransTig 800	80 A
10.5000.0005	FRONIUS TransTig 2200	220 A
10.5000.0009	FRONIUS TransTig 2500	250 A
10.5000.0013	FRONIUS TransTig 3000	300 A
10.5000.0017	FRONIUS TransTig 4000	400 A
10.5000.0045	LORCH T 180 DC	180 A
10.5000.0049	LORCH T 220 DC	220 A
10.5000.0041	LORCH V30 mobil DC	300 A
10.5000.0053	EWM Tetrix 352 DC	TIG, 300A

TIG AC/DC

Item No.	Item	Info
10.5000.0101	FRONIUS MagicWave 2200	220 A
10.5000.0105	FRONIUS MagicWave 2500	250 A
10.5000.0109	FRONIUS MagicWave 3000	300 A
10.5000.0113	FRONIUS MagicWave 4000	400 A
10.5000.0137	LORCH T 180 AC/DC	180 A
10.5000.0141	LORCH T 220 AC/DC	220 A
10.5000.0133	LORCH V30 mobil AC/DC	300 A
10.5000.0145	EWM Tetrix 352 AC/DC	TIG, 300A

PLASMA DC

Item No.	Item	Info
10.5000.1001	FRONIUS TT 2200 PM10	220 A
10.5000.1005	FRONIUS TT 3000 PM10	300 A
10.5000.1017	MIG-O-MAT PlasmaJET 250	250 A

PLASMA AC/DC

Item No.	Item	Info
10.5000.1101	FRONIUS MW 2200 PM10	220 A
10.5000.1105	FRONIUS MW 3000 PM10	300 A

TORCH COOLING

Item No.	Item	Info
10.5000.5001	FRONIUS FK 2200	TT/MW 2200
10.5000.5002	FRONIUS FK 2500	TT/MW 2500 - 3000
10.5000.5005	LORCH WUK 7	T180 -220
10.5000.5006	LORCH WUK 5	V30
10.5000.5007	FRONIUS FK 4000	TT/MW 4000 - 5000

COLDWIRE FEEDER

Item No.	Item	Info
10.5000.5201	FRONIUS KD 4000 D-11	TT / MW
10.5000.5207	LORCH Feed 1	V 30

MIG / MAG (GMAW)

Item No.	Item	Info
10.5000.2004	FRONIUS TPS 320i	320 A
10.5000.2008	FRONIUS TPS 500i	500 A
10.5000.2016	FRONIUS TPS 500i CMT	500 A
10.5000.2036	LORCH S5 SpeedPulse XT	400 A
10.5000.2040	LORCH S8 SpeedPulse XT	500 A
10.5000.2044	EWM Titan XQ 400 AC Puls	400 A
10.5000.2048	CLOOS Qineo NexT 452	450 A

MIG / MAG (GMAW) Remote

Item No.	Item	Info
10.5000.2101	FRONIUS RCUi	TPSi
10.5000.2102	LORCH RC	SpeedPulse XT
10.5000.2103	EWM RC XQ Expert 2.0	Titan XQ
10.5000.2104	CLOOS RPU	Qineo NexT

PLASMA KEYHOLE

Item No.	Item	Info
10.5000.3004	FRONIUS TT4000 PM10	400 A
10.5000.3008	FRONIUS MW4000 PM10	400 A
10.5000.3020	MIG-O-MAT PlasmaJET 350	350 A

PLASMA KEYHOLE OPTIONS

Item No.	Item	Info
10.5000.3101	FRONIUS Option TIG	TIG Torch PAP
10.5000.3102	MIG-O-MAT Option TIG	TIG Torch

HIGH PERFORMANCE TIG

Item No.	Item	Info
10.5000.4004	FRONIUS TT 4000 IF 500	Kjellberg InFocus Torch
10.5000.4008	FRONIUS TT 5000 IF 1000	Kjellberg InFocus Torch
10.5000.4012	FRONIUS TT 5000 ArcTig	FRONIUS ArcTig Torch
10.5000.4016	FRONIUS TT 9400 IF 1000	Powersharing
10.5000.4020	FRONIUS TT 9400 ArcTig	Powersharing
10.5000.4044	KJELLBERG FOCUS TIG 1000 KD	1000 A
10.5000.4048	EWM ForceTIG 1000 KD	1000 A

ADDITIONALS

WATER CHILLER UNIT

Item No.	Item	Info
10.4000.0001	HYFRA eChilly 1 CE	max. 300A
10.4000.0002	HYFRA eChilly 2 CE	max. 500A
10.4000.0003	HYFRA eChilly 3 CE	max. 700 A
10.4000.0004	PfannenberG RACK 1000 UL	max. 300A
10.4000.0005	SMC HRS CE	max. 1000 A
10.4000.0006	SMC HRS UL	max. 1000 A

WELD FUME EXTRACTION

Item No.	Item	Info
10.4100.0001	TEKA Handycart	movable
10.4100.0002	FUMATOR	movable
10.4100.0003	Preperation Pack	movable

WELDING MONITORING SYSTEM

Item No.	Item	Info
10.4200.0001	HKS WeldQAS	TIG
10.4200.0002	HKS WeldQAS	TIG KD
10.4200.0003	HKS WeldQAS	Plasma
10.4200.0004	HKS WeldQAS	Plasma KD

CAM TECHNOLOGY

Item No.	Item	Info
10.4300.0001	FRONIUS ArcView SINGEL	Welding camera
10.4300.0002	POLYTEC Crosshair generator	Adjusting cam

HANDLING SYSTEM

Item No.	Item	Info
10.4400.0001	Insertion Aid	Roller track 600
10.4400.0002	Insertion Aid	Roller track 800
10.4400.0003	Insertion Aid	Roller track 1000
10.4400.0004	Insertion Aid	Roller track 1200
10.4400.0005	Insertion Aid	Roller track 1400
10.4400.0006	Insertion Aid	Roller track 1600
10.4400.0012	Insertion Trolley manuel	L 500
10.4400.0013	Insertion Trolley manuel	L 1100
10.4400.0014	Insertion Trolley electric (Battery)	L 500
10.4400.0015	Insertion Trolley electric (Battery)	L 1100

ELECTRIC COMPONENTS

Item No.	Item	Info
10.4500.0001	Barcode Scanner	Parameter Loading
10.4500.0002	Air Condition - Electric Cabinet	35°C +
10.4500.0004	Ethernet Connection box	Fiber Cabel

ADDITIONAL KITS

Item No.	Item	Info
10.4700.0001	Welding Starter Kit TIG	ABITIG MT 300 W
10.4700.0002	Welding Starter Kit TIG	ABITIG MT 260 W
10.4700.0003	Welding Starter Kit TIG	TTW 4500
10.4700.0004	Welding Starter Kit Plasma	PTW 3500
10.4700.0005	Welding Starter Kit Plasma	PJB 250
10.4700.0016	ToolKit	Start Up / Set Up
10.4700.0017	NEUTRIX Tungstengrinder	Moveable

SERVICE & CARE

PACKAGING

Item No.	Item	Info
10.8000.0001	Wooden pallett	Truck transport only
10.8000.0007	Wooden Box Sea	for Seafare
10.8000.0013	Wooden Box Air	for Land and Airfare

TRAINING

Item No.	Item	Info
10.8100.0001	StartUp & Training Package	2 D on side incl. travel
10.8100.0004	Endacceptance Package	3 D on side incl. travel

TRANSPORT (Incoterms® 2020)

Item No.	Item	Info
10.8200.0001	FCA	Schnelldorf
10.8200.0006	FCA	DE
10.8200.0011	FCA	EU
10.8200.0021	DAP	DE
10.8200.0026	DAP	EU

CARE

Item No.	Item	Info
10.8300.0002	Sparepart package small	Pneumatics, Sensors
10.8300.0005	Sparepart package Full	Pneumatics, Sensors, PLC
10.8300.0008	Service Contract - 1 Year	X-Series
10.8300.0010	Service Contract - 2 Year	X-Series
10.8300.0013	Warrenty Extention 24 Month	X-Series

X SERIES



Schnelldorfer Maschinenbau GmbH

Kappelweg 6 | 91625 Schnelldorf | GERMANY

info@schnelldorfer-maschinenbau.de | +49 (0) 7950 9889 - 0



#PartOfPerfectWeldTechnology